

5R series (5R77)

7R series (7R31, 7R87, 7R88, 7R89, 7R99)



SEIKO WATCH CORPORATION

BGSDD-2310

Operating Instructions

Thank you very much for choosing a CREDOR watch.

Only the unique melding of traditional Japanese sensitivity and state-of-the-art technology can bring you a watch of this quality and character.

Doing so is our passion. The CREDOR name is your guarantee. From the French “crête d’or” or “crest of gold” it signifies our commitment to always being the very best.

We hope this CREDOR watch will be your favorite personal timepiece for many years to come.

Please read carefully the instructions in this booklet for proper and safe use of your CREDOR watch before start using it.

If your watch has a protective film for preventing scratches, make sure to peel it off before using the watch. If the watch is used with the film on it, dirt, sweat, dust, or moisture may be attached to the film and may cause rust.

CONTENTS

■ HANDLING CAUTIONS	3
■ PERFORMANCE AND TYPE	4
■ WATER RESISTANT PERFORMANCE	4
■ CAUTIONS ON WATER RESISTANCE	5
■ CHARACTERISTICS	6
■ NAMES OF THE PARTS	6
■ HOW TO USE	10
• Crown	10
• How to wind the mainspring (7R series)	11
• How to wind the mainspring (5R series)	12
• Power reserve indicator	13
• How to use (For Cal. 7R31)	15
• How to use (For Cal. 7R87, 7R88)	16
• How to use (For Cal. 7R99)	18
• How to use (For Cal. 7R89, 5R77)	19
■ TO PRESERVE THE QUALITY OF YOUR WATCH	22
• After-sale service	22
• Daily care	23
• Remarks on 18-karat gold	23
• Watch body / metal bracelet	23
• Band	24
• How to use an adjustable three-fold clasp	25
• Magnetic resistance (Magnetic influence)	26
• Lumibrite	27
• Troubleshooting	28
■ SPECIFICATIONS (Movement)	30

■ HANDLING CAUTIONS

⚠ WARNING To indicate the risks of serious consequences such as severe injuries unless the following safety regulations are strictly observed.

Immediately stop wearing the watch in the following cases.

- If the watch body or band becomes edged by corrosion etc.
- If the pins protrude from the band.
- * Immediately consult the retailer from whom the watch was purchased or SEIKO CUSTOMER SERVICE CENTER.

Keep the watch and accessories out of the reach of babies and children.

Care should be taken to prevent a baby or a child accidentally swallowing the accessories. If a baby or child swallows the battery or accessories, immediately consult a doctor, as it will be harmful to the health of the baby or child.

⚠ CAUTION To indicate the risks of light injuries or material damages unless the following safety regulations are strictly observed.

Avoid wearing or storing the watch in the following places.

- Places where volatile agents (cosmetics such as polish remover, bug repellent, thinners, etc.) are vaporizing
- Places where the temperature drops below 5°C or rises above 35°C for a long time
- Places affected by strong vibrations
- Places affected by strong magnetism or static electricity
- Places of high humidity
- Dusty places

If you observe any allergic symptoms or skin irritation

Stop wearing the watch immediately and consult a specialist such as a dermatologist or an allergist.

Other cautions

- Do not disassemble or tamper with the watch.
- Please follow local government directions when disposing of the watch body.
- Keep the watch out of the reach of babies and children. Extra care should be taken to avoid risks of any injury or allergic rash or itching that may be caused when they touch the watch.
- If your watch is of the fob or pendant type, the strap or chain attached to the watch may damage your clothes, or injure the hand, neck, or other parts of your body.
- Please keep in mind that if a watch is taken off and placed down as it is, the case back, the band and the clasp will rub against each other possibly causing scratches on the case back. We recommend placing a soft cloth between the case back, the band and the clasp after taking off your watch.

■ PERFORMANCE AND TYPE

The case back shows the performance and type of your watch.

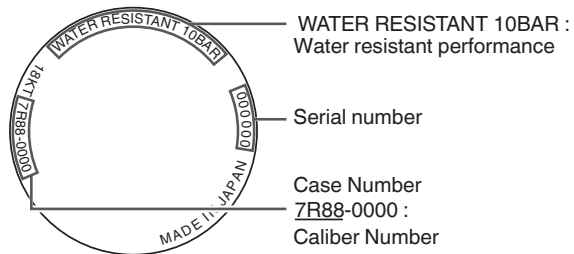

- **Water resistant performance**
Please refer to P. 4.
- **Case number**
The number to identify the type of your watch
- **Serial number**
The number to identify your watch

* The above illustrations are examples and may differ from the case back of the watch you purchased.

■ WATER RESISTANT PERFORMANCE

Refer to the table below for the description of each degree of water resistant performance of your watch before using.

Indication on the case back	Water resistant performance	Conditions of Use
No indication	Non-water resistance	Avoid drops of water or sweat
WATER RESISTANT	Water resistance for everyday life	The watch withstands accidental contact with water in everyday life ⚠ WARNING Not suitable for swimming
WATER RESISTANT 5 BAR	Water resistance for everyday life at 5 barometric pressures	The watch is suitable for swimming.
WATER RESISTANT 10 (20) BAR	Water resistance for everyday life at 10 (20) barometric pressures	The watch is suitable for diving not using an air cylinder.

■ CAUTIONS ON WATER RESISTANCE

⚠ WARNING



Do not use the watch in scuba diving or saturation diving.

The various tightened inspections under simulated harsh environment, which are usually required for watches designed for scuba diving or saturation diving, have not been conducted. For diving, use watches specifically designed for diving.

⚠ CAUTION



Do not pour running water directly from faucet.

The water pressure of tap water from a faucet is high enough to degrade the water resistant performance of a water resistant watch for everyday life.



Do not turn or pull out the crown when the watch is wet.

Water may get inside of the watch.

* If the inner surface of the glass is clouded with condensation or water droplets appear inside of the watch for a long time, the water resistant performance of the watch is deteriorated. Immediately consult the retailer from whom the watch was purchased or SEIKO CUSTOMER SERVICE CENTER.



Do not leave moisture, sweat and dirt on the watch for a long time.

Be aware of a risk that a water resistant watch may lessen its water resistant performance because of deterioration of the adhesive on the glass or gasket, or the development of rust on stainless steel.



Do not wear the watch while taking a bath or a sauna.

Steam, soap or some components of a hot spring may accelerate the deterioration of water resistant performance of the watch.

CHARACTERISTICS

- This watch features “Spring drive”, the unique mechanism made available only by SEIKO technology.
- The Spring Drive watch ensures quartz accuracy while using the mainspring as its sole power source.
- The glide-motion seconds hand moves in a perfectly smooth movement.

CAUTION

- Spring Drive works by the power provided by the mainspring. Remember to check the power reserve indicator and keep the mainspring of the watch sufficiently wound while using the watch.
“Power reserve indicator”→ P. 13
- Under a low-temperature condition (below 0 °C), the watch may stop if the watch power shown by the power reserve indicator falls below one-fourth (7R series) or one-sixth (5R series, 7R31).
Turn the crown to wind the mainspring.

NAMES OF THE PARTS

Please check the caliber number of your watch before reading each operating instruction. The caliber number can be checked on the case back of your watch. “PERFORMANCE AND TYPE”→ P. 4

* The caliber number identifies your watch type.

* The orientation and design of the display may vary depending on the model.

7R31

<Dial side>



- ① Hour hand
- ② Seconds hand
- ③ Minute hand
- ④ Crown
→ P. 10

How to wind the mainspring (7R series)→ P. 11
How to use (For Cal. 7R31)→ P. 15

<Case back side>

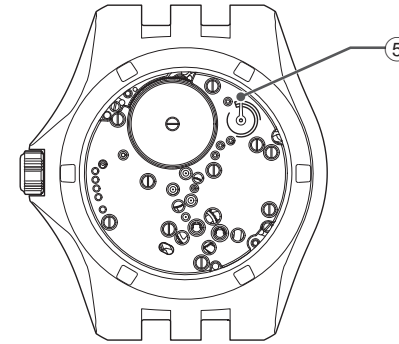

- ⑤ Power reserve indicator
→ P. 13

7R87

Manual winding type with date setting function

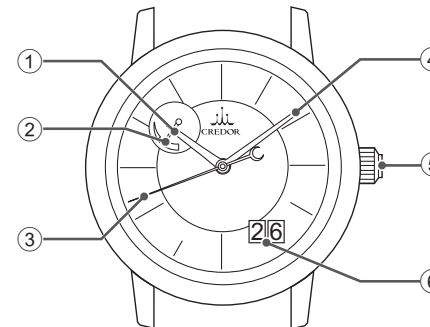

- ① Hour hand
- ② Power reserve indicator
→ P. 13
- ③ Seconds hand
- ④ Minute hand
- ⑤ Crown
→ P. 10
- ⑥ Date

How to wind the mainspring (7R series)→ P. 11
How to use (For Cal. 7R87, 7R88)→ P. 16

7R88

Manual winding type with date setting function

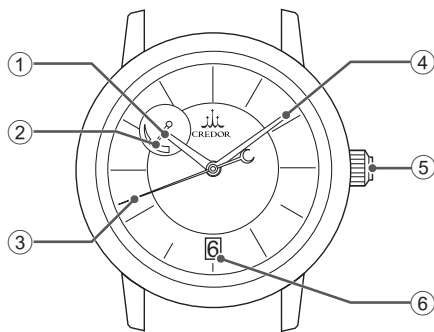

- ① Hour hand
- ② Power reserve indicator
→ P. 13
- ③ Seconds hand
- ④ Minute hand
- ⑤ Crown
→ P. 10
- ⑥ Date

How to wind the mainspring (7R series)→ P. 11
How to use (For Cal. 7R87, 7R88)→ P. 16

7R89

Manual winding type with moon phase display function

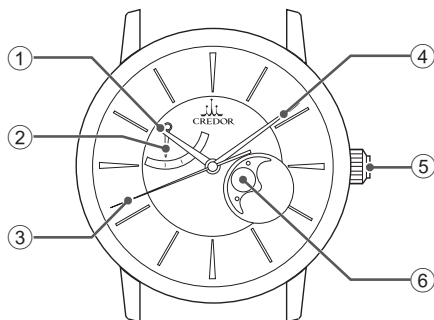

- ① Hour hand
- ② Power reserve indicator
→ P. 13
- ③ Seconds hand
- ④ Minute hand
- ⑤ Crown
→ P. 10
- ⑥ Moon phase display

How to wind the mainspring (7R series)→ P. 11
How to use (For Cal. 7R89, 5R77)→ P. 19

7R99

Manual winding type

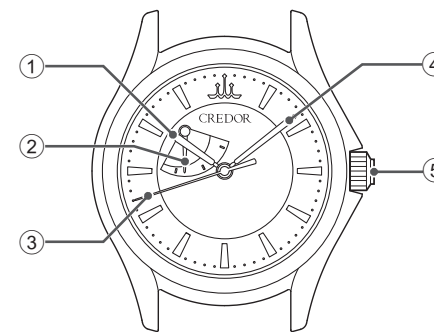

- ① Hour hand
- ② Power reserve indicator
→ P. 13
- ③ Seconds hand
- ④ Minute hand
- ⑤ Crown
→ P. 10

How to wind the mainspring (7R series)→ P. 11
How to use (For Cal. 7R99)→ P. 18

5R77

Automatic type (with manual winding function) featuring moon phase display function

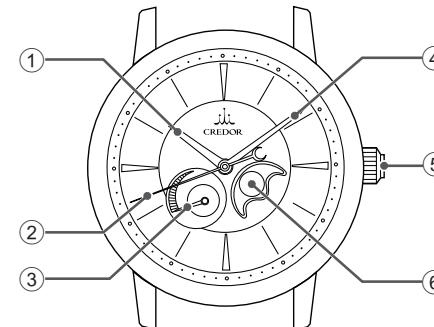

- ① Hour hand
- ② Seconds hand
- ③ Power reserve indicator
→ P. 13
- ④ Minute hand
- ⑤ Crown
→ P. 10
- ⑥ Moon phase display

How to wind the mainspring (5R series)→ P. 12
How to use (For Cal. 7R89, 5R77)→ P. 19

HOW TO USE

Crown

There are two types of crowns, the regular one and one that can be locked. Please confirm the crown of the watch that you are using.

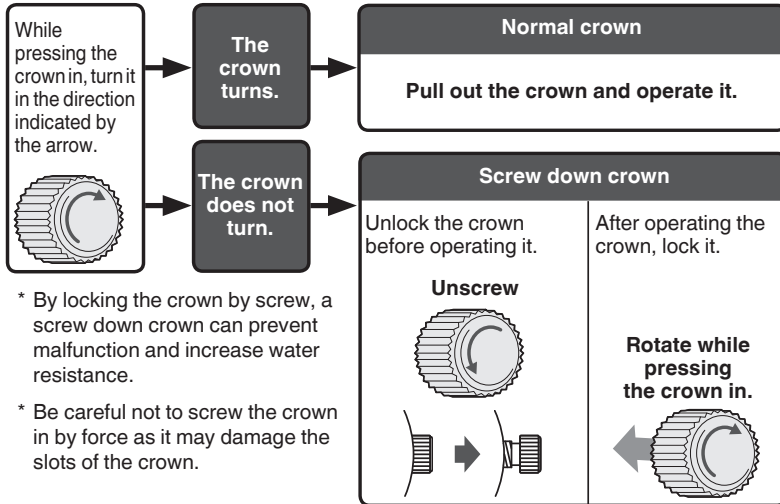

* By locking the crown by screw, a screw down crown can prevent malfunction and increase water resistance.

* Be careful not to screw the crown in by force as it may damage the slots of the crown.

* Turn the crown from time to time. → P. 23

How to wind the mainspring (7R series)

This watch has a manually wound spring drive. You can wind the crown to wind the mainspring to drive the watch.

Guide for winding state of the mainspring

Manual winding : Seven full rotations of the crown will provide the power to run the watch for approximately ten hours.

Observe the power reserve indicator to check the level of the remaining power. "Power reserve indicator"→ P. 13

* Under a low-temperature condition (below 0 °C), always keep at least one-fourth of the watch power, or one-sixth for 7R31, shown by the power reserve indicator. The watch may stop if this condition is not met.

How to manually wind the mainspring

- ① Turn the crown at the normal position clockwise (12 o'clock direction) slowly. (If the watch is equipped with the screw down crown, unscrew the crown before pulling it out.)

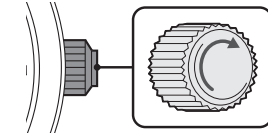

- ② Wind the mainspring until the power reserve indicator shows a fully wound state. "Power reserve indicator"→ P. 13
- ③ Make sure that the seconds hand is moving. (If the crown of your watch is a screw lock type, lock the crown.)

⚠ CAUTION

The crown cannot be turned further when the mainspring is fully wound to prevent overwinding of the mainspring. Do not try to forcefully turn the crown as this may damage the watch.

How to wind the mainspring (5R series)

This watch is an automatic winding type (with manual winding function). When the watch is worn on the wrist, the motion of the wearer's arm winds the mainspring to operate the watch.

You can also manually wind the mainspring by turning the crown.

Guide for winding state of the mainspring

Automatic winding: The mainspring of the watch becomes fully wound when the watch is worn for twelve hours per day for three to five consecutive days.

Manual winding : Five full rotations of the crown will provide the power to run the watch for approximately ten hours.

Observe the power reserve indicator to check the level of the remaining power.
"Power reserve indicator"→ P. 13

* Under a low-temperature condition (below 0 °C), always keep at least one-sixth of the watch power shown by the power reserve indicator.
The watch may stop.

How to manually wind the mainspring

- Turn the crown at the normal position clockwise (12 o'clock direction) slowly.
(If the watch is equipped with the screw down crown, unscrew the crown before pulling it out.)

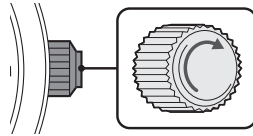

- Wind the mainspring until the power reserve indicator shows a fully wound state.
"Power reserve indicator"→ P. 13
- Make sure that the seconds hand is moving.
(If the crown of your watch is a screw lock type, lock the crown.)

* The crown can be turned further when the mainspring is fully wound.
Turning the crown after the mainspring is fully wound will not damage the watch, however, please refrain from excessive operation because the mainspring cannot be wound any further.

Power reserve indicator

The power reserve indicator lets you know the winding state of the mainspring.

Before removing the watch from your wrist, observe the power reserve indicator to check if the watch has stored enough power to keep running until the next time you wear it. If necessary, wind the mainspring.

(To prevent the watch from stopping, wind the mainspring to store the excess power that will allow the watch to run for extra time.)

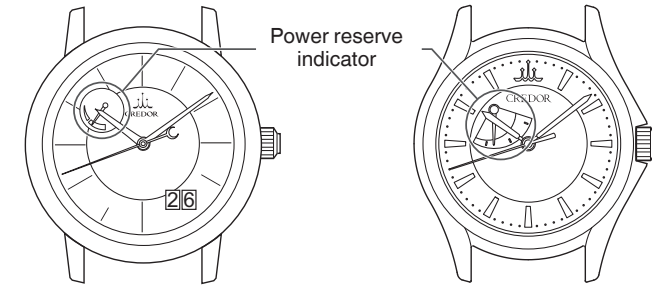

- * The power reserve for automatic winding type watches (5R series) varies depending on your use conditions (watch wearing, time of use, amount of movement during use, etc.).
- * In a case where you wear the watch for a short period of time, observe the power reserve indicator to check the level of the remaining power. If necessary, manually wind the mainspring.

How to read the power reserve indicator

Power reserve indicator				
Winding state of the mainspring	Fully wound	Half wound	Unwound	
Number of hours the watch can run	7R series	Approximately 48 hours (2 days)	Approximately 24 hours (1 day)	The watch either stops or is running down.
	5R series	Approximately 72 hours (3 days)	Approximately 36 hours (1.5 days)	

<For 7R31>

The power reserve indicator is on the case back of the watch.

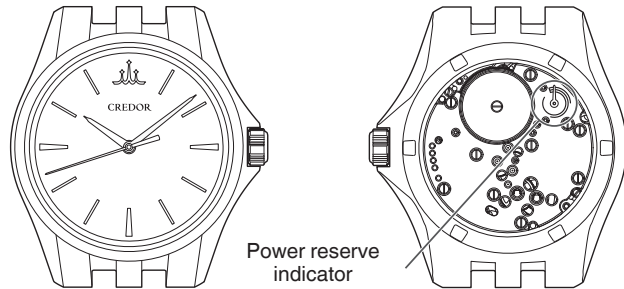

How to read the power reserve indicator

Power reserve indicator			
Winding state of the mainspring	Fully wound	Half wound	Unwound
Number of hours the watch can run	Approximately 72 hours (3 days)	Approximately 36 hours (1.5 days)	The watch either stops or is running down.

* The crown cannot be turned further when the mainspring is fully wound to prevent overwinding of the mainspring. Do not try to forcefully turn the crown as this may damage the watch.

How to use (For Cal. 7R31)

How to set the time

① Make sure that the watch is operating.
To carry out the procedure, please make sure that the watch is in working state.
Please wind the mainspring when the watch is not working.
"How to wind the mainspring (7R series)"→ P. 11

② Pull out the crown when the seconds hand is at the 12 o'clock position.
(The seconds hand stops.)
(If the watch is equipped with the screw down crown, unscrew the crown before pulling it out.)



③ Turn the crown counterclockwise (6 o'clock direction) to advance the hands to set the current time.



④ Push the crown back into the normal position in accordance with a time signal.
(If the crown of your watch is a screw lock type, lock the crown.)

Tips for more accurate time setting

To ensure effective operation of the Spring Drive mechanism, observe the following instructions when you set the time.

- ① Before setting the time, make sure to wind the mainspring sufficiently.
(Ensure that the power reserve indicator is showing a fully wound state.)
- ② When starting to use a watch after it stops, wind the mainspring sufficiently. To set the time after that, wait for approximately 30 seconds after the seconds hand starts moving, then pull the crown out to the first click.
- ③ The seconds hand will stop moving when the crown is pulled out to the first click. Do not stop the movement of the seconds hand for longer than 30 minutes. If the stoppage of the seconds hand movement exceeds 30 minutes, push the crown back in, and wait for approximately 30 seconds after the seconds hand restarts moving, and then set the time.

How to use (For Cal. 7R87, 7R88)

⚠ CAUTION

- Do not adjust the date when the time the watch indicates between 9:00 p.m. and 1:00 a.m. If the date is adjusted in this condition, the date may not change properly the following day, or a malfunction may occur.
- If you set the date when the time the watch indicates between 9:00 p.m. and 1:00 a.m., pull out the crown to the second click, and turn it counterclockwise (6 o'clock direction) to advance the hour hand until it passes 1:00 a.m. temporarily, and then set the date.

How to set the time and date

This watch is equipped with the date display function. The date changes once every 24 hours around midnight.

Therefore, if the a.m./p.m. is incorrectly set, the date will change around 12:00 p.m.

- ① Make sure that the watch is operating.
To carry out the procedure, please make sure that the watch is in working state. Please wind the mainspring when the watch is not working.
"How to wind the mainspring (7R series)" → P. 11

- ② Pull out the crown to the first click.
(If the watch is equipped with the screw down crown, unscrew the crown before pulling it out.)
* The watch keeps on operating.

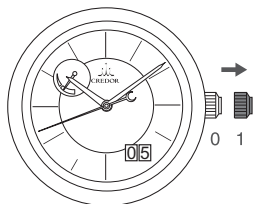

- ③ The date can be adjusted by turning the crown counterclockwise (6 o'clock direction).
First turn the crown counterclockwise until the previous day's date from the desired date appears.

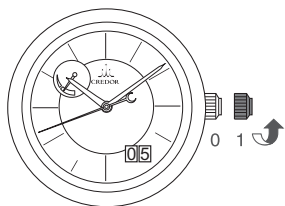

[Ex.] If you want to set the date to "6," set the date to "5" by turning the crown counterclockwise.

- ④ Pull out the crown to the second click when the seconds hand is at the 12 o'clock position. (The seconds hand stops.)
Turn the crown counterclockwise (6 o'clock direction) to advance the hands until the desired date appears. If the date changes, it means that the watch is set in the morning. Turn the crown further until the watch is set to the current time.
Set the minute hand about ten minutes behind and then slowly advance the minute hand to the desired time.

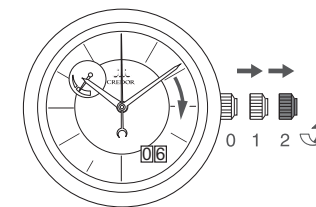

- ⑤ Push the crown back into the normal position in accordance with a time signal. The watch starts operating.
(If the crown of your watch is a screw lock type, lock the crown.)

Date adjustment at the end of the month

It is necessary to adjust the date after February (which has 28 days, 29 days in a leap year) and a 30 day month.

[Ex.] To adjust the date in the a.m. period on the first day of a month following a 30-day month

On the first day, "31" is displayed. Pull out the crown to the first click. Turn the crown counterclockwise (6 o'clock direction) to set the date to "1," and push the crown back into the normal position.

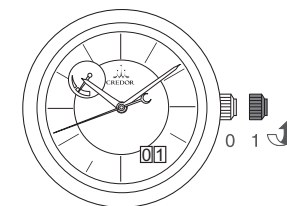

⚠ CAUTION

- Do not adjust the date when the time the watch indicates between 9:00 p.m. and 1:00 a.m. → P. 16
- For models with a screw down crown, remember to screw the crown in.

Tips for more accurate time setting

To ensure effective operation of the Spring Drive mechanism, observe the following instructions when you set the time.

- ① Before setting the time, make sure to wind the mainspring sufficiently.
(Ensure that the power reserve indicator is showing a fully wound state.)
- ② When starting to use a watch after it stops, wind the mainspring sufficiently. To set the time after that, wait for approximately 30 seconds after the seconds hand starts moving, then pull the crown out to the second click.
- ③ The seconds hand will stop moving when the crown is pulled out to the second click. Do not stop the movement of the seconds hand for longer than 30 minutes. If the stoppage of the seconds hand movement exceeds 30 minutes, push the crown back in, and wait for approximately 30 seconds after the seconds hand restarts moving, and then set the time.

How to use (For Cal. 7R99)

How to set the time

- ① Make sure that the watch is operating.
To carry out the procedure, please make sure that the watch is in working state.
Please wind the mainspring when the watch is not working.
“How to wind the mainspring (7R series)”→ P. 11

- ② Pull out the crown when the seconds hand is at the 12 o'clock position.
(The seconds hand stops.)
(If the watch is equipped with the screw down crown, unscrew the crown before pulling it out.)

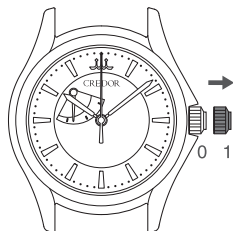

- ③ Turn the crown to set the hour and minute hands to the time.
Set the minute hand about ten minutes behind and then slowly advance the minute hand to the desired time.



- ④ Push the crown back into the normal position in accordance with a time signal.
(If the crown of your watch is a screw lock type, lock the crown.)

Tips for more accurate time setting

To ensure effective operation of the Spring Drive mechanism, observe the following instructions when you set the time.

- ① Before setting the time, make sure to wind the mainspring sufficiently.
(Ensure that the power reserve indicator is showing a fully wound state.)
- ② When starting to use a watch after it stops, wind the mainspring sufficiently. To set the time after that, wait for approximately 30 seconds after the seconds hand starts moving, then pull the crown out to the first click.
- ③ The seconds hand will stop moving when the crown is pulled out to the first click. Do not stop the movement of the seconds hand for longer than 30 minutes. If the stoppage of the seconds hand movement exceeds 30 minutes, push the crown back in, and wait for approximately 30 seconds after the seconds hand restarts moving, and then set the time.

How to use (For Cal. 7R89, 5R77)

When setting the time and moon phase, set the time first and then set the moon phase.

How to set the time

- ① Make sure that the watch is operating.
To carry out the procedure, please make sure that the watch is in working state.
Please wind the mainspring when the watch is not working.
“How to wind the mainspring (7R series)”→ P. 11
“How to wind the mainspring (5R series)”→ P. 12

- ② Pull out the crown to the second click when the seconds hand is at the 12 o'clock position. (The seconds hand stops.)
(If the watch is equipped with the screw down crown, unscrew the crown before pulling it out.)

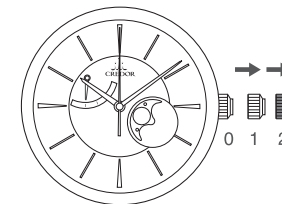



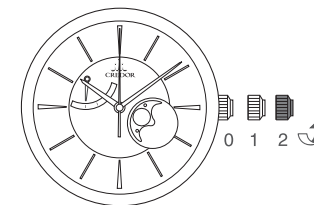









- ③ Turn the crown counterclockwise (6 o'clock direction) to advance the hands to set the time.
Set the minute hand about ten minutes behind and then slowly advance the minute hand to the desired time.



- * It is designed so that the moon phase changes once every 24 hours while the time is shown by a 12-hour display.
- ④ Push the crown back into the normal position in accordance with a time signal. The watch starts operating.
(If the crown of your watch is a screw lock type, lock the crown.)

How to set the moon phase

This watch is equipped with a moon phase display function. The shape of the moon on the moon phase display indicates the approximate moon phase. After setting the time, set the moon phase.

Moon phase		0	7	15	22
The name of moon phase		 New moon	 Quarter moon	 Full moon	 Waning moon
Moon phase display	Ex.1		 moon		
	Ex.2		 moon		

* The moon phase display shows the phases (waxing and waning) of the moon. The moon phase represents the period from the time when the last new moon (moon phase: 0.0) occurred to noon of the current day in day increments. The average length of the period between new moons is approximately 29.5 days.

* The shape of the moon on the moon phase display shows the moon phase, and does not show the shape of the moon itself.

⚠ CAUTION

- Do not adjust the moon phase when the time the watch indicates between 9:00 and 2:00. Amending the moon phase during this time period may cause damage.
- If the watch hands show any time between 9:00 and 2:00, pull out the crown to the second click, and turn it counterclockwise (6 o'clock direction) to temporarily advance the time past 2:00. Adjust the time to the correct time after setting the moon phase.

- ① Check the current moon phase.
* Check the current moon phase from the weather and moon phase data page in your local newspaper.

- ② Pull out the crown to the first click.
(If the watch is equipped with the screw down crown, unscrew the crown before pulling it out.)

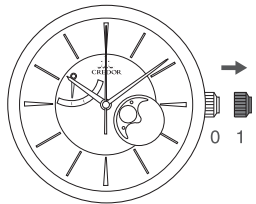

- ③ Turn the crown counterclockwise (6 o'clock direction) to hide the moon on the moon phase display.

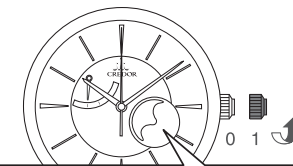

 Whole moon is hidden (the state of "Moon phase 0 (new moon)")

- ④ Turn the crown counterclockwise (6 o'clock direction) to advance the moon phase by one until the correct moon phase is displayed. Round off the number of the moon phase to the first decimal place.

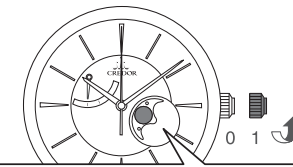

[Ex.] If the current moon phase is 14.8, set the moon phase to "moon phase 15."

 Moon phase 0 →  Moon phase 15

- ⑤ Push the crown back in to the normal position.
(If the crown of your watch is a screw lock type, lock the crown.)

Tips for more accurate time setting

To ensure effective operation of the Spring Drive mechanism, observe the following instructions when you set the time.

- ① Before setting the time, make sure to wind the mainspring sufficiently. (Ensure that the power reserve indicator is showing a fully wound state.)
- ② When starting to use a watch after it stops, wind the mainspring sufficiently. To set the time after that, wait for approximately 30 seconds after the seconds hand starts moving, then pull the crown out to the second click.
- ③ The seconds hand will stop moving when the crown is pulled out to the second click. Do not stop the movement of the seconds hand for longer than 30 minutes. If the stoppage of the seconds hand movement exceeds 30 minutes, push the crown back in, and wait for approximately 30 seconds after the seconds hand restarts moving, and then set the time.

■ TO PRESERVE THE QUALITY OF YOUR WATCH

After-sale service

Notes on guarantee and repair

- Contact the retailer from whom the watch was purchased or SEIKO CUSTOMER SERVICE CENTER for repair or overhaul.
- Within the guarantee period, present the certificate of guarantee to receive repair services.
- Guarantee coverage is provided in the certificate of guarantee. Read carefully and retain it.
- For repair services after the guarantee period has expired, if the functions of the watch can be restored by repair work, we will undertake repair services upon request and payment.

Replacement parts

- Please keep in mind that if original parts are not available, they may be replaced with substitutes whose outward appearance may differ from the originals.

Inspection and adjustment by disassembly and cleaning (overhaul)

- Periodic inspection and adjustment by disassembly and cleaning (overhaul) is recommended approximately once every 3 to 4 years in order to maintain optimal performance of the watch for a long time.
- The movement of this watch has a structure that consistent pressure is applied on its power-transmitting wheels. To ensure these parts work together properly, periodic inspection including cleaning of parts and movement, oiling, adjustment of accuracy, functional check and replacement of worn parts is needed. Inspection and adjustment by disassembly and cleaning (overhaul) within 3 to 4 years from the date of purchase is highly recommended for longtime use of your watch. According to use conditions, the oil retaining condition of your watch mechanical parts may deteriorate, abrasion of the parts may occur due to contamination of oil, which may ultimately lead the watch to stop.
As the parts such as the gasket may deteriorate, water-resistant performance may be impaired due to intrusion of perspiration and moisture.
Please contact the retailer from whom the watch was purchased for inspection and adjustment by disassembly and cleaning (overhaul). For replacement of parts, please specify "SEIKO GENUINE PARTS". When asking for inspection and adjustment by disassembly and cleaning (overhaul), make sure that the gasket and push pin are also replaced with new ones.
- When your watch is inspected and adjusted by disassembly and cleaning (overhauled), the movement of your watch may be replaced.

Daily care

The watch requires good daily care

- The watch body and band touch the skin directly just as underwear.
Keep the watch body and band clean in order to avoid stain on the sleeve edge or rash or itch.
- After removing the watch from your wrist, wipe perspiration or moisture with a soft cloth as soon as possible.
- Do not use any chemical agent such as cleaner to clean the watch.

Turn the crown from time to time. (Only several turns in slow movement will be enough.)

- This prevents corrosion of the crown and helps to extend the life of the gasket in use.
- The same practice should be applied to a screw down crown. (No need to pull out the screw down crown.)
"Crown"→ P. 10
- Stainless steel is a highly rust-resistant metal. However, rust will form if contaminants are left on it for a long time.

Remarks on 18-karat gold

- 18-karat gold (18KT) is an alloy comprised of 75% of gold and 25% of other metals.
Depending on the proportion of the other metals mixed with the gold, the 18-karat gold is classified into three colors such as yellow gold (YG), white gold (WG) and pink gold (PG).

Decoloration of 18-karat gold

- While gold can maintain its glittering quality, other metal components in the alloy may discolor to look like reddish or blackish due to various reasons.
- Daily care helps to prevent discoloration of the alloy, however, if the discoloration or stain of the alloy persists even after wiping the watch off, take your watch to the retailer from whom the watch was purchased for refinishing. (Refinishing will be done at a cost.)

Watch body / metal bracelet

Length adjustment service

- For the length adjustment service of the 18-karat gold or platinum bracelet, ask the retailer from whom the watch was purchased.
The watch will be submitted to CREDOR SERVICE STUDIO for the length adjustment.
It may take two to three weeks depending on the model to adjust the length of the bracelet.
- The length adjustment service of the 18-karat gold, platinum or stainless steel mesh bracelet will not be charged only for the first time. However, the cost for materials or parts necessary for the length adjustment and repair cost other than the length adjustment will be charged.
- The length adjustment service of stainless-steel band is available from the retailer from whom the watch was purchased or SEIKO CUSTOMER SERVICE CENTER. Some other retailers may charge you for the length adjustment or may not undertake such treatments.

Periodic cleaning

- Periodic cleaning is highly recommended to enjoy the best quality of the watch for a long time.
Ask the retailer from whom the watch was purchased or the CREDOR SERVICE STUDIO through your nearby CREDOR retailers. (Cleaning may be done at a cost.)

Band

The band touches the skin directly and becomes dirty from sweat or dust. Therefore, lack of care may accelerate deterioration of the band or cause skin irritation or stain on the sleeve edge. The watch requires a lot of attention for long usage.

Metallic band

- Moisture, sweat or soil will cause rust even on a stainless steel band if they are left for a long time.
- Lack of care may cause a yellowish or gold stain on the lower sleeve edge of shirts.
- Wipe off moisture, sweat or soil with a soft cloth as soon as possible.
- To clean the soil around the joint gaps of the band, wipe it out in water and then brush it off with a soft toothbrush. (Protect the watch body from water splashes by wrapping it up in plastic wrap etc.)
Wipe off the remaining moisture with a soft cloth.
- Because some titanium bracelets use pins made of stainless steel, which has outstanding strength, rust may form in the stainless steel parts.
- If rust advances, pins may poke out or drop out, and the watch case may fall off the bracelet, or the clasp may not open.
- If a pin is poking out, personal injury may result. In such a case, refrain from using the watch and request repair.

Leather band

- A leather band is susceptible to discoloration and deterioration from moisture, sweat and direct sunlight.
- Wipe off moisture and sweat as soon as possible by gently blotting them up with a dry cloth.
- Do not expose the watch to direct sunlight for a long time.
- Please take care when wearing a watch with light-colored band, as dirt is likely to show up.
- Refrain from wearing a leather band watch other than Aqua Free bands while swimming, and when working with water even if the watch itself is water-resistant enforced for daily use.

Polyurethane band

- A polyurethane band is susceptible to discoloration from light, and may be deteriorated by solvent or atmospheric humidity.
- Especially a translucent, white, or pale colored band easily adsorbs other colors, resulting in color smears or discoloration.
- Wash out dirt in water and clean it off with a dry cloth.
(Protect the watch body from water splashes by wrapping it up in plastic wrap etc.)
- When the band becomes less flexible, have the band replaced with a new one. If you continue to use the band as it is, the band may develop cracks or become brittle over time.

Notes on skin irritation and allergy

Skin irritation caused by a band has various reasons such as allergy to metals or leathers, or skin reactions against friction on dust or the band itself.

Notes on the length of the band

Adjust the band to allow a little clearance with your wrist to ensure proper airflow. When wearing the watch, leave enough room to insert a finger between the band and your wrist.



How to use an adjustable three-fold clasp

Adjustable three-fold clasp

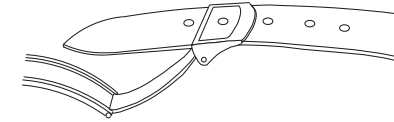

How to adjust the length of the band

- ① Thread the tip of the band to the buckle.
- ② Slide the band to adjust its length and find the appropriate hole. Place the pin into the hole.

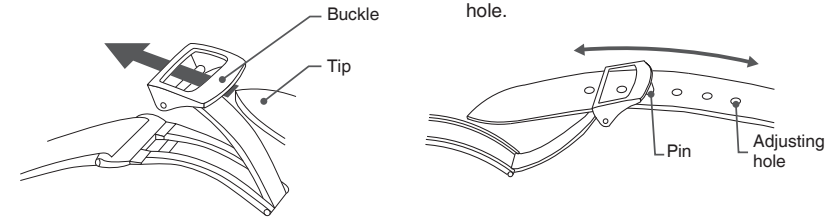

How to wear the watch

Insert the tip of the band into the fixed loop and movable loop, and push the buckle down to fasten the clasp.

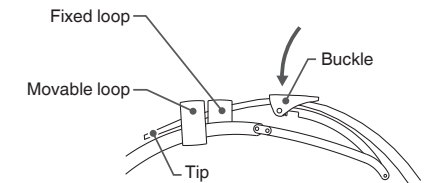

How to take off the watch

Place your finger between the band and clasp. Pinch the band with your fingers and pull it forward to open the clasp.

* Do not pull the tip of the band to open the clasp, as this may damage the band.

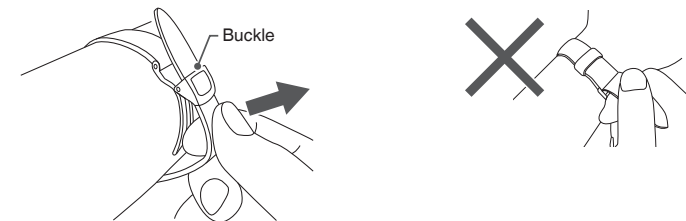

* If it is difficult to open the band following the above procedure, hold both sides of the buckle to open the clasp.

Magnetic resistance (Magnetic influence)

Affected by nearby magnetism, a watch may temporarily gain or lose time or stop operating. This watch is a magnetic resistant watch that is fully compliant with JIS level-1 standard.

Conditions of use	
Keep the watch more than 5 cm away from magnetic products.	(JIS-1)

If the watch becomes magnetized and its accuracy deteriorates to an extent exceeding the specified rate under normal use, the watch may need to be demagnetized. In this case, you will be charged for demagnetization and accuracy readjustment even if it happens within the guarantee period.

Examples of common magnetic products that may affect watches

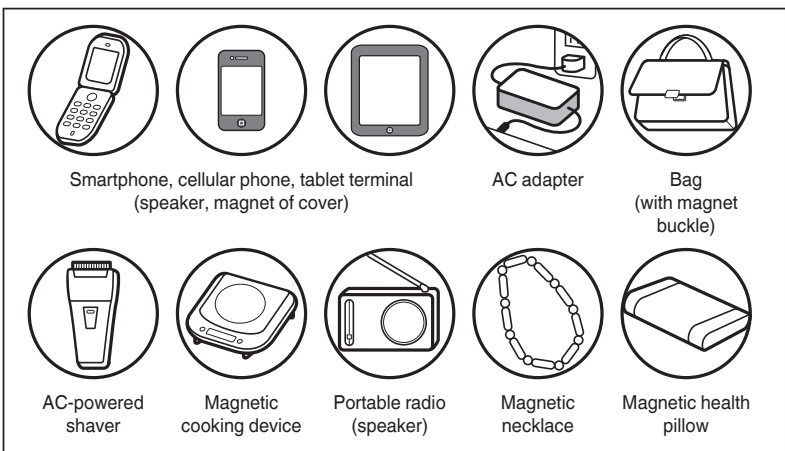

The reason why this watch is affected by magnetism

The built-in speed-regulating mechanism is provided with a magnet, which may be influenced by a strong external magnetic field.

Lumibrite

If your watch has Lumibrite

Lumibrite is a luminous paint that absorbs light energy of the sunlight and lighting apparatus in a short time and stores it to emit light in the dark. For example, if exposed to a light of more than 500 lux for approximately 10 minutes, Lumibrite can emit light for 3 to 5 hours. Please note, however, Lumibrite emits the light it stores, the luminance level of the light decreases gradually over time. The duration of the emitted light may also differ slightly depending on such factors as the brightness of the place where the watch is exposed to light and the distance from the light source to the watch.

- * In general, when you enter a dark place from a bright environment, your eye cannot adapt to the change in light levels quickly. At first, you can hardly see anything, but as time passes, your vision gradually improves. (Dark adaptation of the human eye)
- * Lumibrite is a luminous paint that is completely harmless to human beings and the natural environment; containing no noxious materials such as radioactive substance.

Reference data on the luminance

Condition		Illumination
Sunlight	Fine weather	100,000 lux
	Cloudy weather	10,000 lux
Indoor (Window-side during daytime)	Fine weather	more than 3,000 lux
	Cloudy weather	1,000 to 3,000 lux
	Rainy weather	less than 1,000 lux
Lighting apparatus (40-watt daylight fluorescent light)	Distance to the watch: 1 m	1,000 lux
	Distance to the watch: 3 m	500 lux (average room luminance)
	Distance to the watch: 4 m	250 lux

Troubleshooting

Troubles	Possible causes	Solutions
The watch stops operating.	The mainspring has not been wound.	<u>Turn the crown to wind the mainspring and reset the time.</u> While you are wearing the watch or when you take it off, check the remaining power shown by the power reserve indicator and wind the mainspring if necessary.
The watch stops even though the power reserve indicator is not showing "0".	The watch has been left at a low temperature (below 0°C).	<u>Turn the crown to wind the mainspring.</u> Under a low-temperature condition (below 0 °C), the watch may stop if the watch power shown by the power reserve indicator falls below one-fourth (7R series) or one-sixth (5R series, 7R31).
The watch temporarily loses/gains time.	The watch has been left in extremely high or low temperatures for a long time.	<u>Return the watch to a normal temperature so that it works accurately as usual, and then reset the time.</u> The watch has been adjusted so that it works accurately when it is worn on your wrist under a normal temperature range between 5°C and 35°C.
	The watch was brought into close contact with a magnetic object.	<u>Correct this condition by moving and keeping the watch away from the magnetic source, and reset the time.</u> If this action does not correct the condition, contact the retailer from whom the watch was purchased.
	The watch was dropped, worn while playing active sports, hit against hard surfaces, or exposed to strong vibrations.	<u>Reset the time.</u> If the watch does not return to its normal accuracy after resetting the time, contact the retailer from whom the watch was purchased.
The date changes during daytime. (7R87, 7R88)	A.m./p.m. is not correctly set.	When you set the time, note that the moment the date changes is midnight. <u>When setting the hour hand, be sure that a.m./p.m. is correctly set.</u>
The watch hands move quicker than usual.	This is not a malfunction.	1. Conduct the following crown operation. (7R87, 7R88, 7R89, 5R77) Normal position → Second click → Normal position (7R31, 7R99) Normal position → First click → Normal position 2. Reset the time.
Even though you wear the watch every day, the power reserve indicator does not move up. (5R series)	The watch is worn on your wrist only for a short period of time, or the amount of arm movement is small.	Wear the watch for an extended period of time. Or turn the crown to wind the mainspring.

Troubles	Possible causes	Solutions
It takes the time to change the date. (7R87, 7R88)	This is not a malfunction. (It is designed that the date change mechanism works between 9:00 p.m. and 1:00 a.m.)	No operation is needed.
Right after starting the watch, it seems that the seconds hand moves more quickly than usual when setting the time.	When the watch starts moving, it takes a little time before the speed-regulating unit starts operating. (This is not a malfunction.)	It takes several seconds before the speed-regulating unit starts operating. To set the time correctly, wait for approximately 30 seconds after the seconds hand starts to move, and set the time.
Blur in the display persists.	Small amount of water has got inside the watch due to deterioration of the gasket, etc.	Consult the retailer from whom the watch was purchased.

* For the solution of troubles other than above, contact the retailer from whom the watch was purchased.

■ SPECIFICATIONS (Movement)

Cal. NO	7R87 7R88	7R89	7R99
Features	Hour hand, minute hand, seconds hand, date, power reserve indicator	Hour hand, minute hand, seconds hand, moon phase display, power reserve indicator	Hour hand, minute hand, seconds hand, power reserve indicator
Frequency of crystal oscillator	32,768 Hz (Hz = Cycles per second)		
Loss/Gain	Within 15 seconds per month (equivalent to 1 second per day) (If the watch is worn on your wrist within normal temperature range between 5 °C and 35 °C.)		
Operational temperature range	-10°C ~ +60°C Under a low-temperature condition (below 0 °C), always keep at least one-fourth of the watch power shown by the power reserve indicator.		
Driving system	Manual winding type		
Duration	Approximately 48 hours* ¹		
IC (Integrated Circuit)	Oscillator, frequency divider, and spring drive control circuit (C-MOS-IC): 1 piece		
Hand movement	Glide motion		
Jewels	30 jewels		32 jewels
Cal. NO	5R77	7R31	
Features	Hour hand, minute hand, seconds hand, moon phase display, power reserve indicator	Hour hand, minute hand, seconds hand, power reserve indicator	
Frequency of crystal oscillator	32,768 Hz (Hz = Cycles per second)		
Loss/Gain	Within 15 seconds per month (equivalent to 1 second per day) (If the watch is worn on your wrist within normal temperature range between 5 °C and 35 °C.)		
Operational temperature range	-10°C ~ +60°C Under a low-temperature condition (below 0 °C), always keep at least one-sixth of the watch power shown by the power reserve indicator.		
Driving system	Automatic winding type (with manual winding function)	Manual winding type	
Duration	Approximately 72 hours* ¹		
IC (Integrated Circuit)	Oscillator, frequency divider, and spring drive control circuit (C-MOS-IC): 1 piece		
Hand movement	Glide motion		
Jewels	30 jewels		

*¹ When the power reserve indicator shows a fully wound state, duration may be shortened depending on the how the product is used.

* The specifications are subject to change without prior notice due to product improvement.