

2L series (2L75)
4L series (4L75)
4S series (4S71 · 4S76 · 4S77 · 4S79)
6L series (6L75)
6S series (6S37 · 6S74 · 6S77 · 6S78 · 6S96 · 6S99)
68 series (6870 · 6890 · 6898 · 6899)
8L series (8L36 · 8L75)
CR series (CR01)



SEIKO WATCH CORPORATION

BGJCC01-2407

Operating Instructions

Thank you very much for choosing a CREDOR watch.

Only the unique melding of traditional Japanese sensitivity and state-of-the-art technology can bring you a watch of this quality and character.

Doing so is our passion. The CREDOR name is your guarantee. From the French “crête d’or” or “crest of gold” it signifies our commitment to always being the very best.

We hope this CREDOR watch will be your favorite personal timepiece for many years to come.

Please read carefully the instructions in this booklet for proper and safe use of your CREDOR watch before start using it.

If your watch has a protective film for preventing scratches, make sure to peel it off before using the watch. If the watch is used with the film on it, dirt, sweat, dust, or moisture may be attached to the film and may cause rust.

CONTENTS

■ HANDLING CAUTIONS	3
■ PERFORMANCE AND TYPE	4
■ WATER RESISTANT PERFORMANCE	4
■ CAUTIONS ON WATER RESISTANCE	5
■ CHARACTERISTICS	6
■ NAMES OF THE PARTS	6
■ HOW TO USE	12
• Crown	12
• How to wind the mainspring	13
• Power reserve indicator	13
• How to use (For models without a seconds hand)	14
• How to use (For models with a seconds hand or a small seconds hand)	15
• How to use (For models with the date)	16
• How to use (For models with the date, day of the week, and a 24-hour hand)	18
• How to use (For models with the date and a 24-hour hand)	22
※ List of time zone differences in major regions of the world	26
• How to use the chronograph (6S series)	27
■ TO PRESERVE THE QUALITY OF YOUR WATCH	31
• After-sale service	31
• Daily care	32
• Remarks on 18-karat gold	32
• Watch body / metal bracelet	32
• Band	33
• How to use an adjustable three-fold clasp	34
• Magnetic resistance (Magnetic influence)	35
• Lumibrite	36
• Troubleshooting	37
■ SPECIFICATIONS (Movement)	38

■ HANDLING CAUTIONS

⚠ WARNING To indicate the risks of serious consequences such as severe injuries unless the following safety regulations are strictly observed.

Immediately stop wearing the watch in the following cases.

- If the watch body or band becomes edged by corrosion etc.
- If the pins protrude from the band.
- * Immediately consult the retailer from whom the watch was purchased or SEIKO CUSTOMER SERVICE CENTER.

Keep the watch and accessories out of the reach of babies and children.

Care should be taken to prevent a baby or a child accidentally swallowing the accessories. If a baby or child swallows the battery or accessories, immediately consult a doctor, as it will be harmful to the health of the baby or child.

⚠ CAUTION To indicate the risks of light injuries or material damages unless the following safety regulations are strictly observed.

Avoid wearing or storing the watch in the following places.

- Places where volatile agents (cosmetics such as polish remover, bug repellent, thinners, etc.) are vaporizing
- Places where the temperature drops below 5°C or rises above 35°C for a long time
- Places affected by strong vibrations
- Places affected by strong magnetism or static electricity
- Places of high humidity
- Dusty places

If you observe any allergic symptoms or skin irritation

Stop wearing the watch immediately and consult a specialist such as a dermatologist or an allergist.

Other cautions

- Do not disassemble or tamper with the watch.
- Please follow local government directions when disposing of the watch body.
- Keep the watch out of the reach of babies and children. Extra care should be taken to avoid risks of any injury or allergic rash or itching that may be caused when they touch the watch.
- If your watch is of the fob or pendant type, the strap or chain attached to the watch may damage your clothes, or injure the hand, neck, or other parts of your body.
- Please keep in mind that if a watch is taken off and placed down as it is, the case back, the band and the clasp will rub against each other possibly causing scratches on the case back. We recommend placing a soft cloth between the case back, the band and the clasp after taking off your watch.

■ PERFORMANCE AND TYPE

The case back shows the performance and type of your watch.

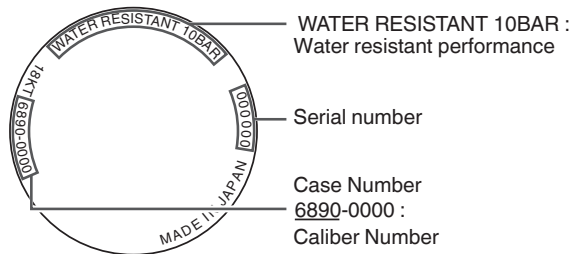

- **Water resistant performance**
Please refer to P. 4.
- **Case number**
The number to identify the type of your watch
- **Serial number**
The number to identify your watch

* The above illustrations are examples and may differ from the case back of the watch you purchased.

■ WATER RESISTANT PERFORMANCE

Refer to the table below for the description of each degree of water resistant performance of your watch before using.

Indication on the case back	Water resistant performance	Conditions of Use
No indication	Non-water resistance	Avoid drops of water or sweat
WATER RESISTANT	Water resistance for everyday life	The watch withstands accidental contact with water in everyday life ⚠ WARNING Not suitable for swimming
WATER RESISTANT 5 BAR	Water resistance for everyday life at 5 barometric pressures	The watch is suitable for swimming.
WATER RESISTANT 10 (20) BAR	Water resistance for everyday life at 10 (20) barometric pressures	The watch is suitable for diving not using an air cylinder.

■ CAUTIONS ON WATER RESISTANCE

⚠ WARNING



Do not use the watch in scuba diving or saturation diving.

The various tightened inspections under simulated harsh environment, which are usually required for watches designed for scuba diving or saturation diving, have not been conducted. For diving, use watches specifically designed for diving.

⚠ CAUTION



Do not pour running water directly from faucet.

The water pressure of tap water from a faucet is high enough to degrade the water resistant performance of a water resistant watch for everyday life.



Do not turn or pull out the crown when the watch is wet.

Water may get inside of the watch.

* If the inner surface of the glass is clouded with condensation or water droplets appear inside of the watch for a long time, the water resistant performance of the watch is deteriorated. Immediately consult the retailer from whom the watch was purchased or SEIKO CUSTOMER SERVICE CENTER.



Do not leave moisture, sweat and dirt on the watch for a long time.

Be aware of a risk that a water resistant watch may lessen its water resistant performance because of deterioration of the adhesive on the glass or gasket, or the development of rust on stainless steel.



Do not wear the watch while taking a bath or a sauna.

Steam, soap or some components of a hot spring may accelerate the deterioration of water resistant performance of the watch.

CHARACTERISTICS

- This watch is a mechanical watch that runs by a mainspring.
- Before using the watch, turn the crown by hand about 20 times to wind up the mainspring of the watch.
- While the loss / gain of a quartz watch is shown by the monthly or yearly rate, the loss / gain of a mechanical watch is shown by the daily rate (loss/gain per one day).
- The loss / gain of a mechanical watch changes delicately day by day, depending on various environment or conditions in which the watch is used (such as temperatures, the amount of time the watch has been worn, the amount of arm movement, and the amount that the mainspring is wound up).
- A mechanical watch may lose / gain time when it is affected by strong magnetism. If the parts of the watch become magnetized, the watch needs repair including demagnetizing. In this case, consult the retailer from whom the watch was purchased.

NAMES OF THE PARTS

Please check the caliber number of your watch before reading each operating instruction. The caliber number can be checked on the case back of your watch. "PERFORMANCE AND TYPE"→ P. 4

* The caliber number identifies your watch type.

* The orientation and design of the display may vary depending on the model.

6870, 6890, 6899

Manual winding type

with one of the world's thinnest movements (1.98 mm)

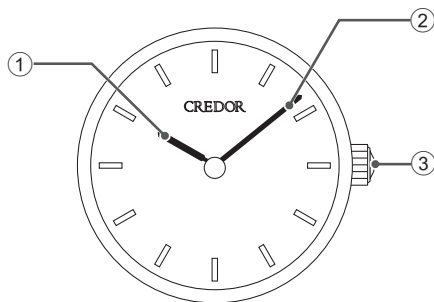

- ① Hour hand
- ② Minute hand
- ③ Crown → P. 12

How to wind the mainspring→ P. 13
How to use (For models without a seconds hand)→ P. 14

6898

Manual winding type

with one of the world's thinnest movements (1.98 mm)

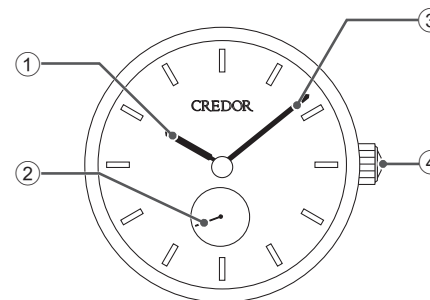

- ① Hour hand
- ② Small seconds hand
- ③ Minute hand
- ④ Crown → P. 12

How to wind the mainspring→ P. 13
How to use (For models with a seconds hand or a small seconds hand)→ P. 15

4S71

Automatic winding type (with manual winding function)

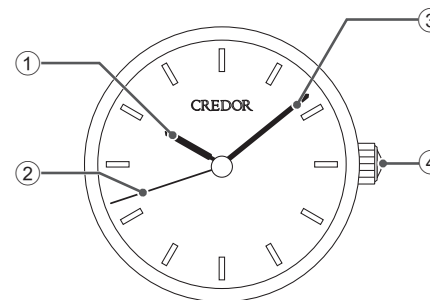

- ① Hour hand
- ② Seconds hand
- ③ Minute hand
- ④ Crown → P. 12

How to wind the mainspring→ P. 13
How to use (For models with a seconds hand or a small seconds hand)→ P. 15

2L75, 4L75, 6L75, 8L75, CR01

Automatic winding type (with manual winding function)
with a date display

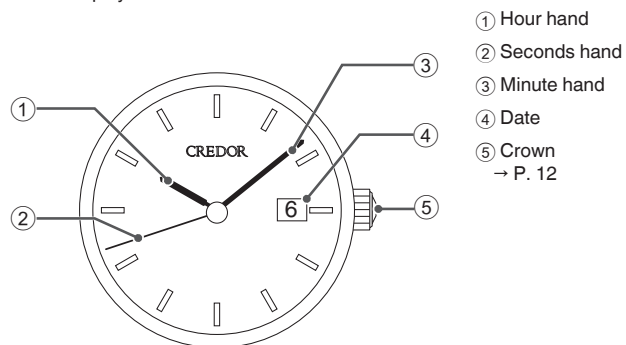

- ① Hour hand
- ② Seconds hand
- ③ Minute hand
- ④ Date
- ⑤ Crown
→ P. 12

How to wind the mainspring → P. 13
How to use (For models with the date) → P. 16

4S76

Automatic winding type (with manual winding function)
with a retrograde-type day hand, time zone adjustment, power reserve indicator, 24-hour hand and date display

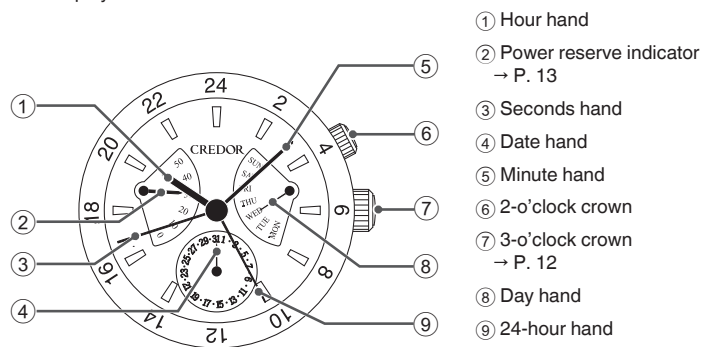

- ① Hour hand
- ② Power reserve indicator
→ P. 13
- ③ Seconds hand
- ④ Date hand
- ⑤ Minute hand
- ⑥ 2-o'clock crown
- ⑦ 3-o'clock crown
→ P. 12
- ⑧ Day hand
- ⑨ 24-hour hand

How to wind the mainspring → P. 13
How to use (For models with the date, day of the week, and a 24-hour hand) → P. 18

4S77

Automatic winding type (with manual winding function)
with a retrograde-type day hand, time zone adjustment, 24-hour hand and date display

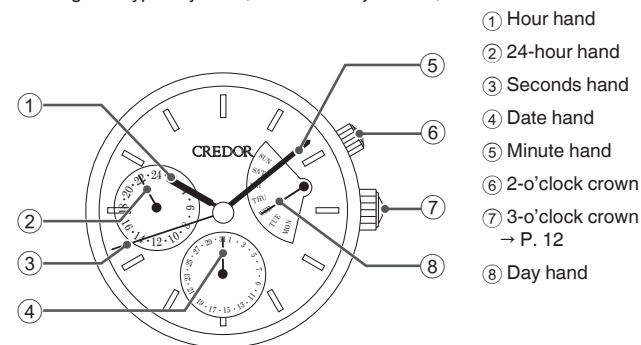

- ① Hour hand
- ② 24-hour hand
- ③ Seconds hand
- ④ Date hand
- ⑤ Minute hand
- ⑥ 2-o'clock crown
- ⑦ 3-o'clock crown
→ P. 12
- ⑧ Day hand

How to wind the mainspring → P. 13
How to use (For models with the date, day of the week, and a 24-hour hand) → P. 18

4S79

Manual winding type
with a power reserve indicator

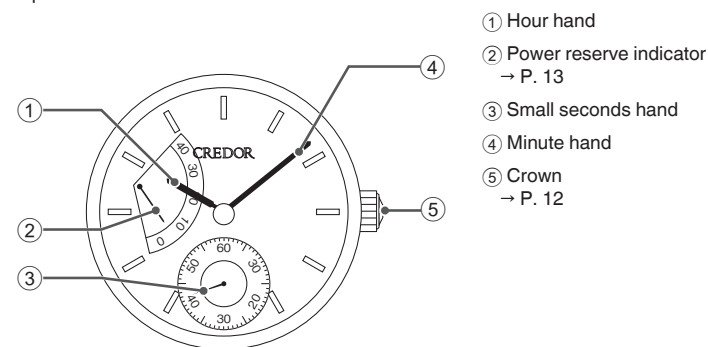

- ① Hour hand
- ② Power reserve indicator
→ P. 13
- ③ Small seconds hand
- ④ Minute hand
- ⑤ Crown
→ P. 12

How to wind the mainspring → P. 13
How to use (For models with a seconds hand or a small seconds hand) → P. 15

8L36

Automatic winding type (with manual winding function)
with time zone adjustment, 24-hour hand and date display

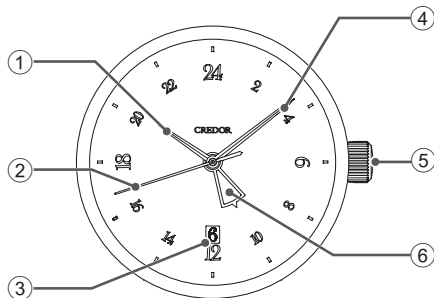

- ① Hour hand
- ② Seconds hand
- ③ Date
- ④ Minute hand
- ⑤ Crown
→ P. 12
- ⑥ 24-hour hand

How to wind the mainspring → P. 13
How to use (For models with the date and a 24-hour hand) → P. 22

6S37, 6S77

Automatic winding type (with manual winding function)
with a power reserve indicator, a chronograph movement and date display

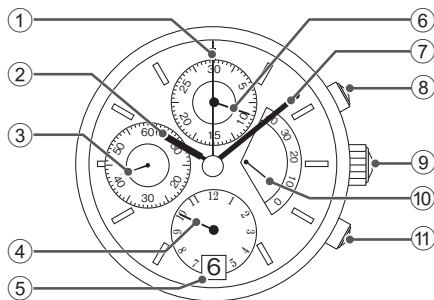

- ① Center chronograph seconds hand
- ② Hour hand
- ③ Small seconds hand
- ④ Chronograph hour hand
- ⑤ Date
- ⑥ Chronograph minute hand
- ⑦ Minute hand
- ⑧ START/STOP button
- ⑨ Crown
→ P. 12
- ⑩ Power reserve indicator
→ P. 13
- ⑪ RESET button

How to wind the mainspring → P. 13
How to use (For models with the date) → P. 16
How to use the chronograph (6S series) → P. 27

6S78

Automatic winding type (with manual winding function)
with a chronograph movement and date display

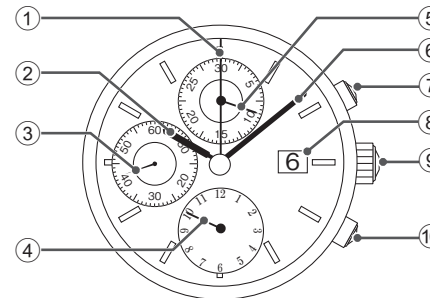

- ① Center chronograph seconds hand
- ② Hour hand
- ③ Small seconds hand
- ④ Chronograph hour hand
- ⑤ Chronograph minute hand
- ⑥ Minute hand
- ⑦ START/STOP button
- ⑧ Date
- ⑨ Crown
→ P. 12
- ⑩ RESET button

How to wind the mainspring → P. 13
How to use (For models with the date) → P. 16
How to use the chronograph (6S series) → P. 27

6S74, 6S96, 6S99

6S74, 6S99: Manual winding type, 6S96: Automatic winding type (with manual winding function)
with a power reserve indicator, a chronograph movement

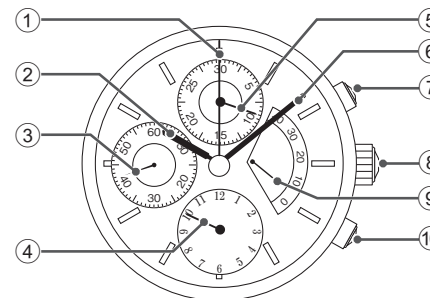

- ① Center chronograph seconds hand
- ② Hour hand
- ③ Small seconds hand
- ④ Chronograph hour hand
- ⑤ Chronograph minute hand
- ⑥ Minute hand
- ⑦ START/STOP button
- ⑧ Crown
→ P. 12
- ⑨ Power reserve indicator
→ P. 13
- ⑩ RESET button

How to wind the mainspring → P. 13
How to use (For models with a seconds hand or a small seconds hand) → P. 15
How to use the chronograph (6S series) → P. 27

HOW TO USE

Crown

There are two types of crowns, the regular one and one that can be locked. Please confirm the crown of the watch that you are using.

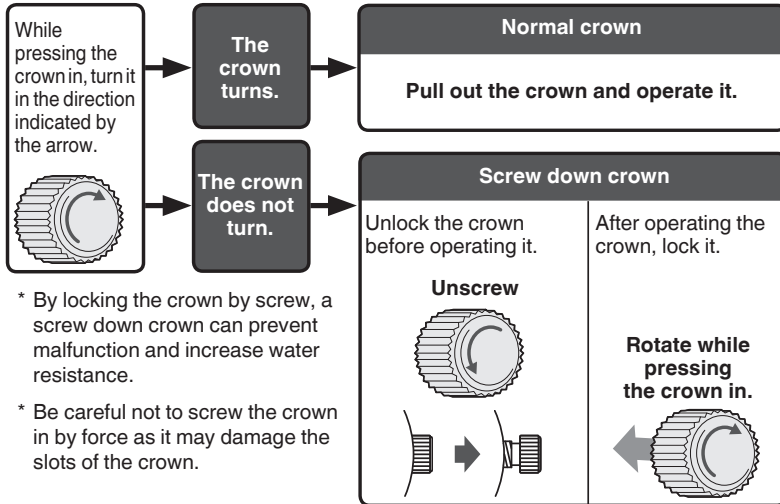

* By locking the crown by screw, a screw down crown can prevent malfunction and increase water resistance.

* Be careful not to screw the crown in by force as it may damage the slots of the crown.

* Turn the crown from time to time. → P. 32

How to wind the mainspring

Manual winding type (the procedure below is the same when you wind up an automatic winding type by hand)

- Do not pull the crown out. (If the watch is equipped with the screw down crown, unscrew the crown before pulling it out.)
- Slowly turn the crown clockwise to wind the mainspring.

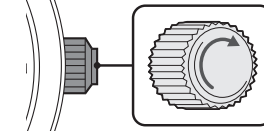

- * When the mainspring approaches full-winding, turning of the crown is heavy more or less, however, this is caused by reaction force of the wound mainspring, which is not defective.
- * It is structured so that the crown can be further turned in the full-winding state. Although it is not necessary to worry about cutting the mainspring, refrain from excessive turning. (2L, 4S, 6L, 6S, 4L 8L and CR01 series)

- Please wind the mainspring fully everyday at a fixed time to keep the watch moving accurately.

CAUTION

In case of 68 series watches that have thin movement, it becomes harder to turn the crown when the mainspring is fully wound up. Be careful not to keep turning the crown forcibly. Otherwise the mainspring may be cut.

Automatic winding type (with manual winding function)

- The mainspring can be sufficiently wound automatically by natural movement of the arm while normally worn on the wrist. In addition, it can be wound by turning the crown.
- A stopped watch can be started by arm movement when it is worn on the wrist, however, before wearing the watch, wind the mainspring sufficiently and adjust the time and date.

* It is recommended that you wear the watch on your wrist more than 10 hours a day to keep the mainspring wound up. If the mainspring is not wound up sufficiently, the watch may lose or gain time. If you use the watch without wearing on your wrist, wind the mainspring up sufficiently by turning the crown by hand every day at a fixed time.

Power reserve indicator

The power reserve indicator lets you know the winding state of the mainspring.

Before removing the watch from your wrist, observe the power reserve indicator to check if the watch has stored enough power to keep running until the next time you wear it. If necessary, wind the mainspring.

(To prevent the watch from stopping, wind the mainspring to store the excess power that will allow the watch to run for extra time.)

How to use (For models without a seconds hand)

Models: 6870, 6890, 6899

How to set the time

- ① Make sure that the watch is operating.
To carry out the procedure, please make sure that the watch is in working state.
Please wind the mainspring when the watch is not working.
“How to wind the mainspring”→ P. 13
- ② Pull out the crown.
(If the watch is equipped with the screw down crown, unscrew the crown before pulling it out.)
* If the watch is a 68 series model, it continues to move when the crown is pulled out.

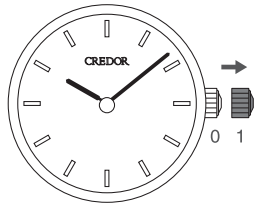

- ③ Turn the crown to set the hour and minute hands to the time.

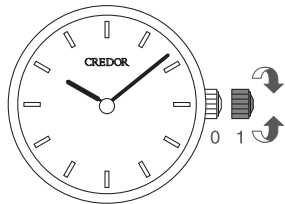

- ④ Push the crown back in to its normal position.
(If the crown of your watch is a screw lock type, lock the crown.)

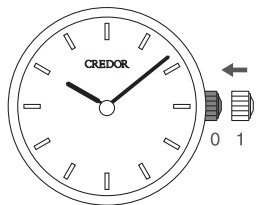

⚠ CAUTION

Due to its gear train mechanism, for setting the time of the mechanical watch correctly, the hands should be set back once slightly and then set forward to the correct time.

How to use (For models with a seconds hand or a small seconds hand)

Models: 6898, 4S71, 4S79, 6S74, 6S96, 6S99

How to set the time

- ① Make sure that the watch is operating.
To carry out the procedure, please make sure that the watch is in working state.
Please wind the mainspring when the watch is not working.
“How to wind the mainspring”→ P. 13
- ② Pull out the crown when the seconds hand (or the small seconds hand) is at the 12 o'clock position. (The seconds hand or the small seconds hand will stop.)
(If the watch is equipped with the screw down crown, unscrew the crown before pulling it out.)
* If the watch is a 6898 model, the small seconds hand continues to move when the crown is pulled out.

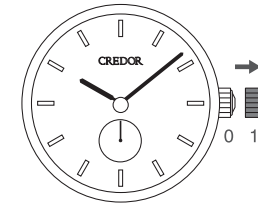

- ③ Turn the crown to set the hour and minute hands to the time.

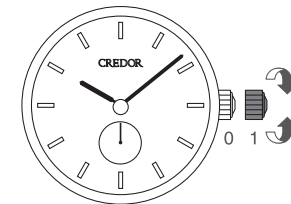

- ④ Push the crown back into the normal position in accordance with a time signal.
(If the crown of your watch is a screw lock type, lock the crown.)

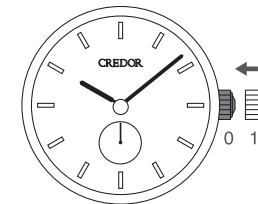

⚠ CAUTION

Due to its gear train mechanism, for setting the time of the mechanical watch correctly, the hands should be set back once slightly and then set forward to the correct time.

How to use (For models with the date)

Models: 2L75, 4L75, 6L75, 8L75, CR01, 6S37, 6S77, 6S78

⚠ CAUTION

Do not amend the date when the watch is displaying between 8:00 p.m. and 2:00 a.m.
If the date is set during this period of time, the date may not change when the next day comes, or this may cause damage.

How to set the time and date

This watch is equipped with the date display function. The date changes once every 24 hours at around midnight.
Therefore, if the a.m./p.m. is incorrectly set, the date will change around 12:00 p.m.

- ① Make sure that the watch is operating.

To carry out the procedure, please make sure that the watch is in working state.
Please wind the mainspring when the watch is not working.
“How to wind the mainspring”→ P. 13

- ② Pull out the crown to the first click.
(If the watch is equipped with the screw down crown, unscrew the crown before pulling it out.)

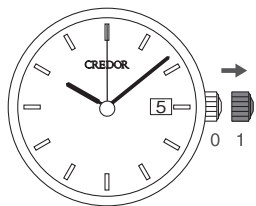

- ③ The date can be adjusted by turning the crown clockwise (12 o'clock direction).
First turn the crown clockwise until the previous day's date from the desired date appears.

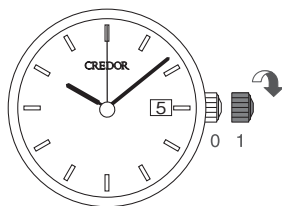

[Ex.] If you want to set the date to “6,” set the date to “5” by turning the crown clockwise.

- ④ Pull out the crown to the second click. Pull out the crown when the seconds hand (or the small seconds hand) is at the 12 o'clock position.
(The seconds hand or the small seconds hand will stop.)

Turn the crown clockwise until the desired date appears. The time is now set for the a.m. period. Further turn the crown to set the current time

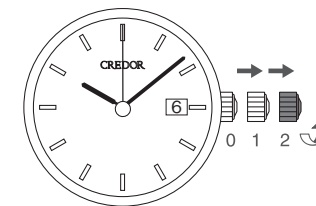

- ⑤ Push the crown back into the normal position in accordance with a time signal. The watch starts operating.
(If the crown of your watch is a screw lock type, lock the crown.)

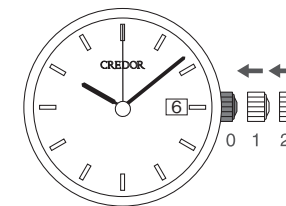

⚠ CAUTION

Due to its gear train mechanism, for setting the time of the mechanical watch correctly, the hands should be set back once slightly and then set forward to the correct time.

Date adjustment at the end of the month

It is necessary to adjust the date after February (which has 28 days, 29 days in a leap year) and a 30 day month.

[Ex.] To adjust the date in the a.m. period on the first day of a month following a 30-day month

On the first day, “31” is displayed. Pull out the crown to the first click. Turn the crown clockwise (12 o'clock direction) to set the date to “1”, and push the crown back in to the normal position.

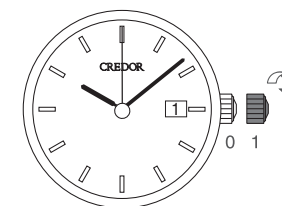

⚠ CAUTION

- For models with a screw down crown, remember to screw the crown in.
- Do not amend the date when the watch is displaying between 8:00 p.m. and 2:00 a.m. Doing so may cause damage.

How to use (For models with the date, day of the week, and a 24-hour hand)

Models: 4S76, 4S77

⚠ CAUTION

Do not adjust the date and day when the time the watch indicates between 9:30 p.m. and 2:30 a.m.
Amending the date or the day of the week during this time period may cause problems such as the date or the day of the week failing to change the next day or may cause damage.

How to set the time, date and day

This watch is equipped with a date and day of the week display function. The date and day of the week change once every 24 hours.
The date changes around midnight, and the day of the week changes at around 2:30 a.m. If the a.m./p.m. is incorrectly set, the date will change at 12 o'clock noon, and the day of the week will change at around 2:30 p.m.

- Make sure that the watch is operating.
To carry out the procedure, please make sure that the watch is in working state.
Please wind the mainspring when the watch is not working.
"How to wind the mainspring" → P. 13

- Pull out the 3 o'clock position crown to the second click.
(If the watch is equipped with the screw down crown, unscrew the crown before pulling it out.)

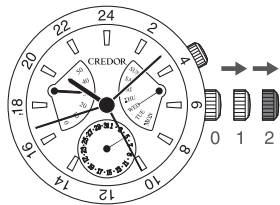

- Turn the 3 o'clock position crown to set the 24-hour hand and the minute hand to the 12 o'clock position.

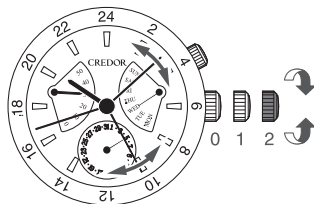

- Push the 3 o'clock position crown back to its normal position.
* If the hour hand is not aligned with the 12 o'clock position, go to step 5.
If the hour hand is aligned with the 12 o'clock position, proceed to step 8.

- Pull out the 2 o'clock position crown to the first click.

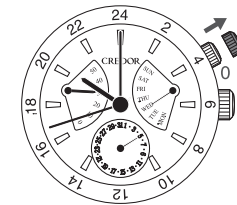

- Turn the 2 o'clock position crown to set the hour hand to the 12 o'clock position.
* The crown can be turned either clockwise or counterclockwise without any problem.

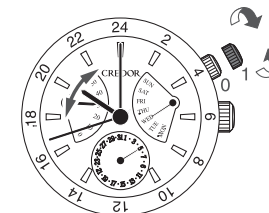

- Push the 2 o'clock position crown back to its normal position.

- Pull out the 3 o'clock position crown to the first click.

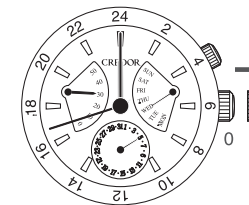

- Turn the 3 o'clock position crown until the previous day's date and day of the week from the desired date appears.

[Ex.] If you want to set the date to "6," set the date to "5" by turning the crown clockwise.

Turn the crown counterclockwise (6 o'clock direction) to set the date, and turn the crown clockwise (12 o'clock direction) to set the day of the week.

* When the day is adjusted by turning the crown clockwise, the mainspring is also wound. This makes turning the crown a little heavy but this is not a malfunction.

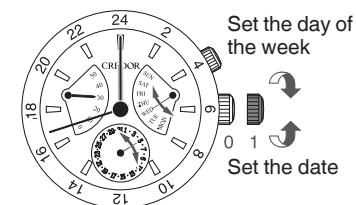

- ⑩ Pull out the 3 o'clock position crown to the second click. Pull out the crown when the seconds hand is at the 12 o'clock position. (The seconds hand will stop.) Turn the 3 o'clock position crown until the desired date and day appears. When the date and day changes, the time is a.m. Further turn the crown to set the current time.

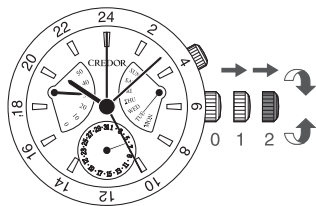

- ⑪ Push the crown back in to the normal position in accordance with a time signal. The watch starts operating. (If the crown of your watch is a screw lock type, lock the crown.)

⚠ CAUTION

- Due to its gear train mechanism, for setting the time of the mechanical watch correctly, the hands should be set back once slightly and then set forward to the correct time.
- Do not turn the minute hand counterclockwise at and around 1:00 a.m. while the date hand is showing "Monday". Otherwise, the hour hand may turn free. If the minute hand is turned clockwise to set the time around 1:00 a.m., the hour hand will not turn free.

Date adjustment at the end of the month

It is necessary to adjust the date after February (which has 28 days, 29 days in a leap year) and a 30 day month.

[Ex.] To adjust the date in the a.m. period on the first day of a month following a 30-day month

On the first day, "31" is displayed. Pull out the crown to the first click. Turn the crown counterclockwise (6 o'clock direction) to set the date to "1," and push the crown back into the normal position.

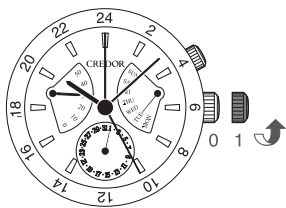

⚠ CAUTION

- For models with a screw down crown, remember to screw the crown in.
- Do not adjust the date when the time the watch indicates between 9:30 p.m. and 2:30 a.m. Doing so may cause damage.

Time difference adjustment function

This caliber is equipped with a "time zone adjustment mechanism." By using the 2 o'clock position crown, the hour hand can be independently adjusted in one-hour increments. This eliminates the trouble of stopping the watch to adjust the time when you travel abroad. In addition, by using the 24-hour hand (GMT hand) at the center of the watch, the watch can be used as a dual time watch that shows home time and local time.

How to use the time difference adjustment function

- ① Check that the 3 o'clock position crown is at its normal position. Then pull out the 2 o'clock position crown to the first click.

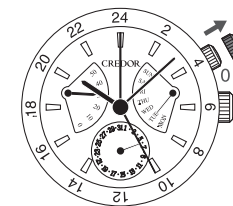

- ② Turn the 2 o'clock position crown to set the time of your destination.

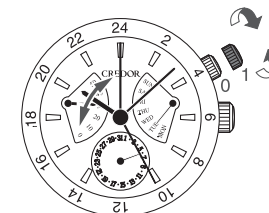

- ③ On completing the adjustment of the 24-hour hand, push the 2 o'clock position crown back to its normal position.
 - * After the hour hand has been adjusted to the local time, the 24-hour hand still shows the original time (home time), allowing the watch to be used as a dual time indicator.

⚠ CAUTION

When adjusting the time zone using the 2 o'clock position crown, if the crown is turned with the 3 o'clock position crown pulled to the second click (where hands can be turned), the time zone adjustment mechanism may fail to work and the time zone may not be adjusted. Therefore, ensure that the 3 o'clock position crown is pushed to its normal position when adjusting the time zone.

How to use (For models with the date and a 24-hour hand)

Model: 8L36

How to set the time and date

This watch is equipped with the date display function. The date changes once every 24 hours at around midnight.

Therefore, if the a.m./p.m. is incorrectly set, the date will change around 12:00 p.m.

To set the time and date, set the 24-hour hand and minute hand first, and then set the hour hand and date.

① Make sure that the watch is operating.

To carry out the procedure, please make sure that the watch is in working state.

Please wind the mainspring when the watch is not working.

"How to wind the mainspring"→ P. 13

② Pull out the crown to the second click when the seconds hand is at the 12 o'clock position. (The seconds hand stops.)

(If the watch is equipped with the screw down crown, unscrew the crown before pulling it out.)

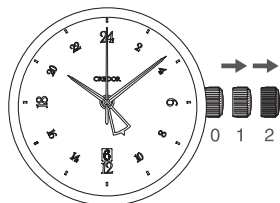

③ Turn the crown clockwise to set the 24-hour and minute hands to the current time of your area.

While doing so, set the minute hand a few minutes behind the correct time, and then slowly advance it to the desired time.

* Only the 24-hour and minute hands are to be set first. Even if the hour hand is indicating incorrect time, or the date may be altered depending on the position of the hour hand, it is not necessary to make an adjustment at this stage.

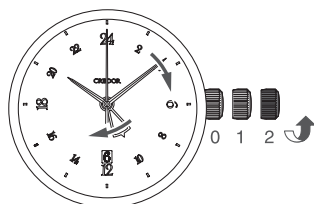

④ Push the crown back in simultaneously with the time signal.

* The setting of the 24-hour, minute and seconds hands is now completed.

⑤ To move on to the hour hand and date setting, pull out the crown to the first click.

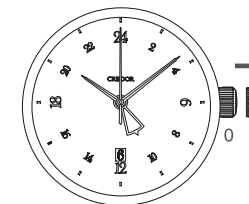

⑥ Turn the crown to set the hour hand. While turning the crown, the moment the date changes is midnight. When setting the hour hand, be sure that a.m./p.m. is set correctly. Set the date also at this point if necessary.

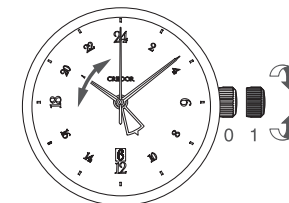

- * The crown can be turned in either direction to set the date, however, it is recommended to turn the crown in the direction which enables you to set the date with a smaller adjustment.
- * Turn the crown slowly, checking that the hour hand moves in one-hour increments.
- * When setting the hour hand, the other hands may move slightly. However, this is not a malfunction.
- * If you set the date between 10 p.m. and 0 a.m. by turning the hour hand counterclockwise, turn the hour hand until it shows sometime between 9 p.m. and 10 p.m. once, then set the date.
- * In case the hour hand is turned counterclockwise, the date will be put back when the hour hand shows around 10 p.m., however, it is not malfunction.

⑦ Push the crown back in to complete the time setting. (If the crown of your watch is a screw lock type, lock the crown.)

Date adjustment at the end of the month

It is necessary to adjust the date after February (which has 28 days, 29 days in a leap year) and a 30 day month.

[Ex.] To adjust the date in the a.m. period on the first day of a month following a 30-day month

On the first day, "31" is displayed. Pull out the crown to the first click. Turn the crown clockwise (12 o'clock direction) to set the date to "1", and push the crown back in to the normal position.

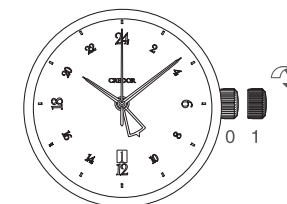

CAUTION

For models with a screw down crown, remember to screw the crown in.

How to use the 24-hour hand

This watch has two different types of 24-hour hand usage.
When you use as a dual time indicator, set the 24-hour and hour hands to different times.

<Type 1> : 24-hour hand as an a.m./p.m. indicator

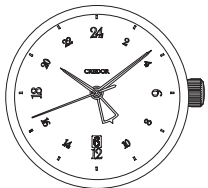

Simply using the 24-hour hand to show the 24-hour time as an a.m./p.m. indicator. (This is the standard usage type for the 24-hour hand.)

Both the hour hand and the 24-hour hand are indicating the Japan time 10:00 a.m.

<Type 2> : 24-hour hand as a dual time indicator

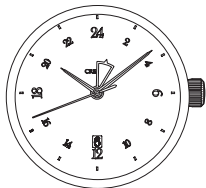

Using the time difference adjustment function, set the 24-hour hand to indicate a time different from the time that the hour and minute hand indicate, which is of a place in a different time zone area with at least one hour of time difference from where you are.

Hour hand : Japan time 10:00 a.m.
24-hour Hand : London time 1:00 a.m.

Time difference adjustment function

For example, while traveling abroad and staying in a place with a different time from where you live, you can conveniently set the watch to indicate the local time in the different time zone area without stopping the watch.

The hour hand indicates the time of the place where you currently are, while the 24-hour hand indicates the time of the place of origin.

The date works in conjunction with the movement of the hour hand. If the time difference is correctly adjusted, the watch displays the correct date of the place where you are staying.

How to use the time difference adjustment function

- Make sure that the watch is operating.
To carry out the procedure, please make sure that the watch is in working state.
Please wind the mainspring when the watch is not working.
"How to wind the mainspring"→ P. 13

- Pull out the crown to the first click.
(If the watch is equipped with the screw down crown, unscrew the crown before pulling it out.)

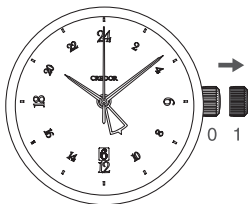

- Turn the crown to set the hour hand to indicate the time of the place where you are staying. Make sure that a.m./p.m. and date are correctly set.
* The date is designed to work in conjunction with the movement of the hour hand, therefore, incorrect setting of a.m./p.m. will cause the date to change at noon.
"List of time zone differences in major regions of the world"→ P. 26

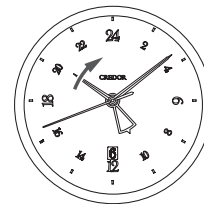

Turning the crown clockwise (12 o'clock direction):
The hour hand is advanced one hour.

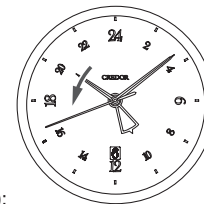

Turning the crown counterclockwise (6 o'clock direction):
The hour hand is set back one hour.

- * The crown can be turned in either direction to set the date, however, it is recommended to turn the crown in the direction which enables you to set the time difference with a smaller adjustment.
 - * Turn the crown slowly, checking that the hour hand moves in one-hour increments.
 - * While turning the crown, the moment the date changes is midnight.
 - * When setting the hour hand, the other hands may move slightly. However, this is not a malfunction.
 - * If you set the date between 10 p.m. and 0 a.m. by turning the hour hand counterclockwise, turn the hour hand until it shows sometime between 9 p.m. and 10 p.m. once, then set the date.
 - * In case the hour hand is turned counterclockwise, the date will be put back when the hour hand shows around 10 p.m., however, it is not malfunction.
- Upon completion of setting, make sure that the time indicated is correct, and then push the crown back in. The setting procedure is now completed.
(If the crown of your watch is a screw lock type, lock the crown.)

List of time zone differences in major regions of the world

* There are time zone differences based on time offsets from Universal Time Coordinated (UTC), which has been internationally adopted. The world is divided into 24 time zones, and neighboring time zones have a one-hour time difference, so that they correspond to the rotation of the earth which makes one full rotation in 24 hours (1 day). In some regions of the world, daylight saving time is individually observed.

* Daylight saving time, being defined as time difference +1 hour, is a system that advances the time by 1 hour during summer time to prolong the daylight hours.

Names of the cities	Time difference from Universal Time Coordinated (UTC)	Time difference from Japan Standard Time (JST)	Other cities in the same region
Tokyo	+9 hours	0 hours	Seoul, Pyongyang
Beijing	+8 hours	-1 hour	Hong Kong, Singapore
Bangkok	+7 hours	-2 hours	Jakarta
Dacca	+6 hours	-3 hours	
Karachi	+5 hours	-4 hours	
Dubai	+4 hours	-5 hours	
Jeddah	+3 hours	-6 hours	Baghdad
Cairo	+2 hours	-7 hours	★Athens
★Paris	+1 hour	-8 hours	★Rome, ★Berlin
★London	0 hours	-9 hours	★Lisbon
★Azores	-1 hour	-10 hours	
Rio de Janeiro	-3 hours	-12 hours	
Santo Domingo	-4 hours	-13 hours	
★New York	-5 hours	-14 hours	★Montreal
★Chicago	-6 hours	-15 hours	★Mexico City
★Denver	-7 hours	-16 hours	
★Los Angeles	-8 hours	-17 hours	★Vancouver
★Anchorage	-9 hours	-18 hours	
Honolulu	-10 hours	-19 hours	
Midway Island	-11 hours	-20 hours	
★Wellington	+12 hours	+3 hours	★Auckland
Nouméa	+11 hours	+2 hours	
★Sydney	+10 hours	+1 hour	Guam

* Regions marked with ★ use daylight saving time

* The time zone differences of each region and use of daylight saving time are based on data as of January 2023. These are subject to change according to the governments of the respective countries or regions.

How to use the chronograph (6S series)

A chronograph is a watch that has a stopwatch function in addition to a time display function. This watch features a stopwatch function which can measure time up to 12 hours in 1/8-second increments.

Before using the stopwatch function

- ① Make sure that the mainspring is sufficiently wound.
When using the stopwatch, ensure that the watch is working.
- ② Make sure that the center chronograph seconds hand is pointing at the 0 position.
If it is not pointing at the 0 position, press the RESET button.
* Do not pull out the crown while the stopwatch function is operating, as doing so will stop the measurement.

Names of the chronograph parts and their function

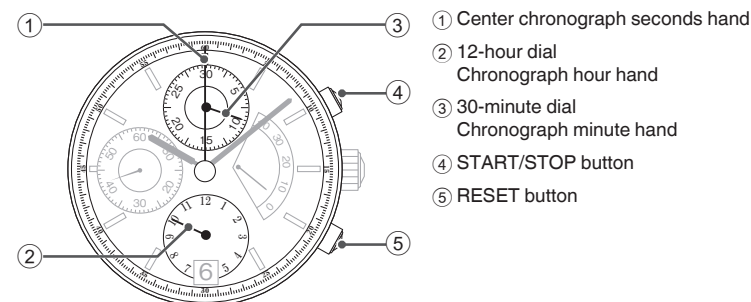

* The orientation and design of the display may vary depending on the model.

How to use the chronograph (stopwatch) function

Press the START/STOP button to begin measuring time.
Pressing START/STOP button repeatedly enables the chronograph to continue to count.

① Make sure that the mainspring is sufficiently wound and the watch is working.

② Start measuring time.
Upon pressing of the START/STOP button, the chronograph hands start moving and the stopwatch starts measuring time.

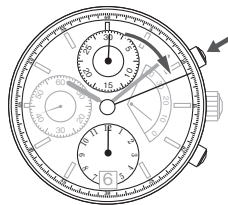

③ Stop measuring time.
At the moment you want to finish the measurement, press the START/STOP button again to stop the chronograph hands.

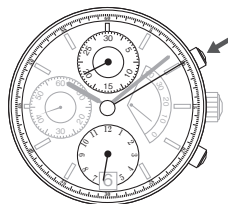

[Ex.] 6 hours 20 minutes
10 seconds and 0

* The chronograph minute hand on the 30-minute dial completes two full rotations in an hour.
To read the 30-minute dial, see the display of the 12-hour dial as a rough indication.

④ Reset the chronograph hands.
After stopping the chronograph hands, press the RESET button to return all the chronograph hands to the 0 position.

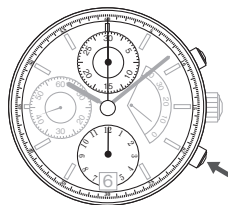

How to use the tachymeter

The tachymeter can be used to measure average speed or productivity rate per unit time.

How to measure average speed of your vehicle

[Ex.] Measure the time taken by your vehicle to go one kilometer

- ① When the car passes the start line, press the START/STOP button to start the stopwatch.
- ② When the car crosses the 1-kilometer mark, press the START/STOP button to stop the stopwatch. Read the number on the tachymeter scale to which the center stopwatch seconds hand is pointing.

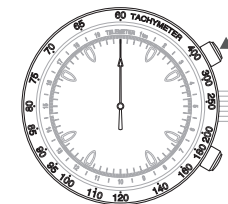

1 km

The measured result shows that the average speed of the vehicle is 80 km/h.

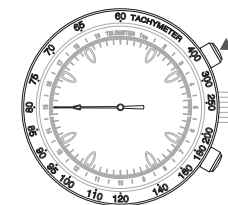

How to compute productivity rate per hour

[Ex.] Measure the time required to produce one unit

- ① At the start of production, press the START/STOP button to start the stopwatch.
- ② When the production is completed, press the START/STOP button to stop the stopwatch. Read the number on the tachymeter scale to which the center stopwatch seconds hand is pointing.

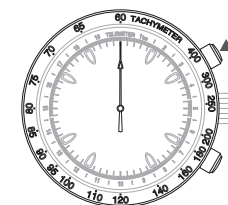

1 unit

The measured result shows that the average productivity rate is 300 units/h.

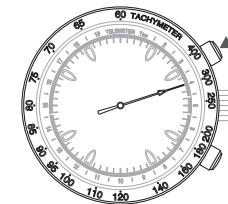

How to use the telemeter

The TELEMETER scale can be used to measure the distance of something (ex: lightning) from the wearer of the watch by the amount of time it takes for a sound to travel.

[Ex.] These are the steps to measure the time from when lightning appeared to when the sound reached the wearer.

- ① Press the START/STOP button when a flash of lightning appears to start the stopwatch.
- ② When the thunder is heard, press the START/STOP button to stop the stopwatch, then read the number on the telemeter at the position indicated by the center stopwatch seconds hand.

The measurement result shows that it is 8km from the point where the wearer is to the point where the lightning struck.

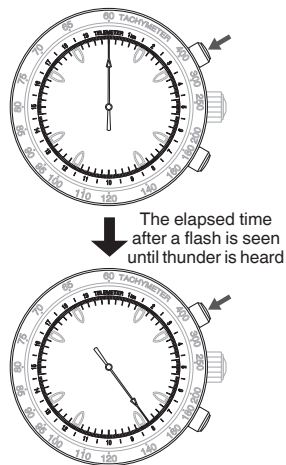

TO PRESERVE THE QUALITY OF YOUR WATCH

After-sale service

Notes on guarantee and repair

- Contact the retailer from whom the watch was purchased or SEIKO CUSTOMER SERVICE CENTER for repair or overhaul.
- Within the guarantee period, present the certificate of guarantee to receive repair services.
- Guarantee coverage is provided in the certificate of guarantee. Read carefully and retain it.
- For repair services after the guarantee period has expired, if the functions of the watch can be restored by repair work, we will undertake repair services upon request and payment.

Replacement parts

- Please keep in mind that if original parts are not available, they may be replaced with substitutes whose outward appearance may differ from the originals.

Inspection and adjustment by disassembly and cleaning (overhaul)

- Periodic inspection and adjustment by disassembly and cleaning (overhaul) is recommended approximately once every 2 to 3 years in order to maintain optimal performance of the watch for a long time.
- The power transmission gear of the movement of this watch constantly receives force. To ensure that this mechanism works properly all the time, washing parts, changing oil, adjusting accuracy, checking functions and replacing consumable parts on a regular basis are important. The first overhaul after the purchase of your watch is particularly important for preserving long-time use of your watch. According to use conditions, the oil retaining condition of your watch mechanical parts may deteriorate, abrasion of the parts may occur due to contamination of oil, which may ultimately lead the watch itself to stop. As the parts such as the gasket may deteriorate, water-resistant performance may be impaired due to intrusion of perspiration and moisture. Please contact the retailer from whom the watch was purchased for inspection and adjustment by disassembly and cleaning (overhaul). For replacement of parts, please specify "SEIKO GENUINE PARTS". When asking for inspection and adjustment by disassembly and cleaning (overhaul), make sure that the gasket and push pin are also replaced with new ones.
- When your watch is inspected and adjusted by disassembly and cleaning (overhauled), the movement of your watch may be replaced.

Daily care

The watch requires good daily care

- The watch body and band touch the skin directly just as underwear.
Keep the watch body and band clean in order to avoid stain on the sleeve edge or rash or itch.
After removing the watch from your wrist, wipe perspiration or moisture with a soft cloth as soon as possible.
- Do not use any chemical agent such as cleaner to clean the watch.

Turn the crown from time to time. (Only several turns in slow movement will be enough.)

- This prevents corrosion of the crown and helps to extend the life of the gasket in use.
- The same practice should be applied to a screw down crown. (No need to pull out the screw down crown.)
“Crown”→ P. 12
- Stainless steel is a highly rust-resistant metal. However, rust will form if contaminants are left on it for a long time.

Remarks on 18-karat gold

- 18-karat gold (18KT) is an alloy comprised of 75% of gold and 25% of other metals.
Depending on the proportion of the other metals mixed with the gold, the 18-karat gold is classified into three colors such as yellow gold (YG), white gold (WG) and pink gold (PG).

Decoloration of 18-karat gold

- While gold can maintain its glittering quality, other metal components in the alloy may discolor to look like reddish or blackish due to various reasons.
- Daily care helps to prevent discoloration of the alloy, however, if the discoloration or stain of the alloy persists even after wiping the watch off, take your watch to the retailer from whom the watch was purchased for refinishing. (Refinishing will be done at a cost.)

Watch body / metal bracelet

Length adjustment service

- For the length adjustment service of the 18-karat gold or platinum bracelet, ask the retailer from whom the watch was purchased.
The watch will be submitted to CREDOR SERVICE STUDIO for the length adjustment.
It may take two to three weeks depending on the model to adjust the length of the bracelet.
- The length adjustment service of the 18-karat gold, platinum or stainless steel mesh bracelet will not be charged only for the first time. However, the cost for materials or parts necessary for the length adjustment and repair cost other than the length adjustment will be charged.
- The length adjustment service of stainless-steel band is available from the retailer from whom the watch was purchased or SEIKO CUSTOMER SERVICE CENTER. Some other retailers may charge you for the length adjustment or may not undertake such treatments.

Periodic cleaning

- Periodic cleaning is highly recommended to enjoy the best quality of the watch for a long time.
Ask the retailer from whom the watch was purchased or the CREDOR SERVICE STUDIO through your nearby CREDOR retailers. (Cleaning may be done at a cost.)

Band

The band touches the skin directly and becomes dirty from sweat or dust. Therefore, lack of care may accelerate deterioration of the band or cause skin irritation or stain on the sleeve edge. The watch requires a lot of attention for long usage.

Metallic band

- Moisture, sweat or soil will cause rust even on a stainless steel band if they are left for a long time.
- Lack of care may cause a yellowish or gold stain on the lower sleeve edge of shirts.
- Wipe off moisture, sweat or soil with a soft cloth as soon as possible.
- To clean the soil around the joint gaps of the band, wipe it out in water and then brush it off with a soft toothbrush. (Protect the watch body from water splashes by wrapping it up in plastic wrap etc.)
Wipe off the remaining moisture with a soft cloth.
- Because some titanium bracelets use pins made of stainless steel, which has outstanding strength, rust may form in the stainless steel parts.
- If rust advances, pins may poke out or drop out, and the watch case may fall off the bracelet, or the clasp may not open.
- If a pin is poking out, personal injury may result. In such a case, refrain from using the watch and request repair.

Leather band

- A leather band is susceptible to discoloration and deterioration from moisture, sweat and direct sunlight.
- Wipe off moisture and sweat as soon as possible by gently blotting them up with a dry cloth.
- Do not expose the watch to direct sunlight for a long time.
- Please take care when wearing a watch with light-colored band, as dirt is likely to show up.
- Refrain from wearing a leather band watch other than Aqua Free bands while swimming, and when working with water even if the watch itself is water-resistant enforced for daily use.

Polyurethane band

- A polyurethane band is susceptible to discoloration from light, and may be deteriorated by solvent or atmospheric humidity.
- Especially a translucent, white or pale colored band easily adsorbs other colors, resulting in color smears or discoloration.
- Wash out dirt in water and clean it off with a dry cloth.
(Protect the watch body from water splashes by wrapping it up in plastic wrap etc.)
- When the band becomes less flexible, have the band replaced with a new one. If you continue to use the band as it is, the band may develop cracks or become brittle over time.

Notes on skin irritation and allergy

Skin irritation caused by a band has various reasons such as allergy to metals or leathers, or skin reactions against friction on dust or the band itself.

Notes on the length of the band

Adjust the band to allow a little clearance with your wrist to ensure proper airflow. When wearing the watch, leave enough room to insert a finger between the band and your wrist.



How to use an adjustable three-fold clasp

Adjustable three-fold clasp

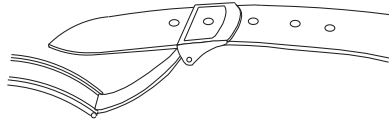

How to adjust the length of the band

- ① Thread the tip of the band to the buckle.
- ② Slide the band to adjust its length and find the appropriate hole. Place the pin into the hole.

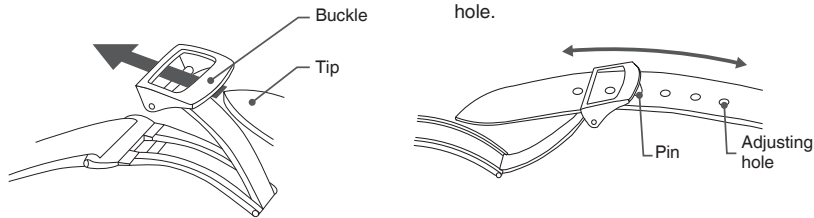

How to wear the watch

Insert the tip of the band into the fixed loop and movable loop, and push the buckle down to fasten the clasp.

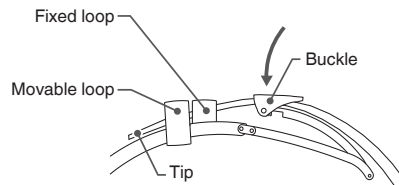

How to take off the watch

Place your finger between the band and clasp. Pinch the band with your fingers and pull it forward to open the clasp.

* Do not pull the tip of the band to open the clasp, as this may damage the band.

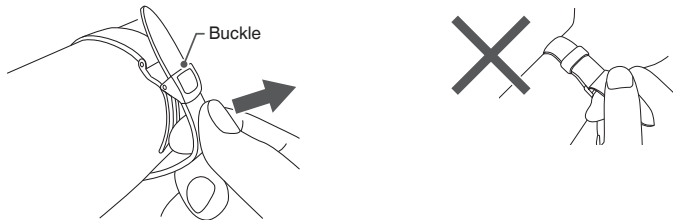

* If it is difficult to open the band following the above procedure, hold both sides of the buckle to open the clasp.

Magnetic resistance (Magnetic influence)

Affected by nearby magnetism, a watch may temporarily gain or lose time or stop operating. This watch is a magnetic resistant watch that is fully compliant with JIS level-1 standard.

Conditions of use	
Keep the watch more than 5 cm away from magnetic products.	(JIS-1)

If the watch becomes magnetized and its accuracy deteriorates to an extent exceeding the specified rate under normal use, the watch may need to be demagnetized. In this case, you will be charged for demagnetization and accuracy readjustment even if it happens within the guarantee period.

Examples of common magnetic products that may affect watches

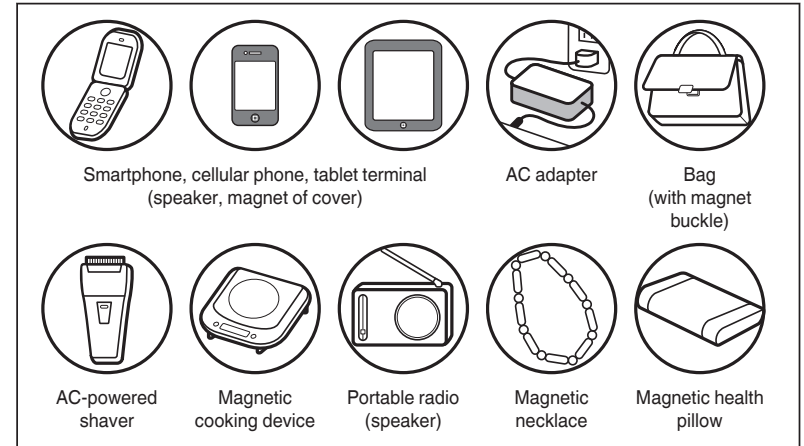

The reason why this watch is affected by magnetism

The built-in balance spring is provided with a magnet, which may be influenced by a strong external magnetic field.

Lumibrite

If your watch has Lumibrite

Lumibrite is a luminous paint that absorbs light energy of the sunlight and lighting apparatus in a short time and stores it to emit light in the dark. For example, if exposed to a light of more than 500 lux for approximately 10 minutes, Lumibrite can emit light for 3 to 5 hours. Please note, however, Lumibrite emits the light it stores, the luminance level of the light decreases gradually over time. The duration of the emitted light may also differ slightly depending on such factors as the brightness of the place where the watch is exposed to light and the distance from the light source to the watch.

* In general, when you enter a dark place from a bright environment, your eye cannot adapt to the change in light levels quickly. At first, you can hardly see anything, but as time passes, your vision gradually improves. (Dark adaptation of the human eye)

* Lumibrite is a luminous paint that is completely harmless to human beings and the natural environment; containing no noxious materials such as radioactive substance.

Reference data on the luminance

Condition		Illumination
Sunlight	Fine weather	100,000 lux
	Cloudy weather	10,000 lux
Indoor (Window-side during daytime)	Fine weather	more than 3,000 lux
	Cloudy weather	1,000 to 3,000 lux
	Rainy weather	less than 1,000 lux
Lighting apparatus (40-watt daylight fluorescent light)	Distance to the watch: 1 m	1,000 lux
	Distance to the watch: 3 m	500 lux (average room luminance)
	Distance to the watch: 4 m	250 lux

Troubleshooting

Troubles	Possible causes	Solutions
The watch stops operating.	The mainspring has not been wound.	Wind the mainspring or swing the watch for a few times so that the watch will start operating. If this action does not correct the condition, consult the retailer from whom the watch was purchased.
The watch loses/gains time.	The watch has been left in extremely high or low temperatures for a long time.	Normal accuracy will resume when the watch returns to normal temperature.
	The watch was brought into close contact with a magnetic object.	Accuracy cannot be recovered. Restoring the original accuracy requires demagnetization (repair). Consult the retailer from whom the watch was purchased.
	The watch was dropped, worn while playing active sports, hit against hard surfaces, or exposed to strong vibrations.	Accuracy cannot be recovered. Consult the retailer from whom the watch was purchased.
	Inspection, adjustment, and overhaul cleaning have not been performed for the watch for more than 3 years.	Consult the retailer from whom the watch was purchased.
The date changes during daytime.	A.m./p.m. is not correctly set.	Advance the hour hand for 12 hours and reset the time and date.
Blur in the display persists.	Small amount of water has got inside the watch due to deterioration of the gasket, etc.	Consult the retailer from whom the watch was purchased.

* For the solution of troubles other than above, contact the retailer from whom the watch was purchased.

■ SPECIFICATIONS (Movement)

Cal. NO	6870	6890	6899	6898
Features	Hour and minute hands			Hour, minute, and small seconds hands
Vibrations/hour	21,600			
Loss/Gain	Daily rate +25 sec. to -15 sec.			
Driving system	Manual winding type			
Duration	Approx. 37 hours			
Jewels	22 jewels		26 jewels	

Cal. NO	2L75	4L75	6L75	CR01	8L75	8L36
Features	Hour, minute, and seconds hands, and date					Hour, minute, and seconds hands, and 24-hour hand
Vibrations/hour	28,800					
Loss/Gain	Daily rate +25 sec. to -15 sec.	Daily rate +15 sec. to -10 sec.				
Driving system	Automatic winding type (with manual winding function)					
Duration	Approx. 50 hours	Approx. 42 hours	Approx. 45 hours		Approx. 50 hours	
Jewels	35 jewels	25 jewels	26 jewels			27 jewels

Cal. NO	4S71	4S76	4S77	4S79
Features	Hour, minute, and seconds hands	Hour, minute, seconds, 24-hour hands, power reserve indicator, date and day hands	Hour, minute, seconds, 24-hour, date, and day hands	Hour, minute, and small seconds hands, and power reserve indicator
Vibrations/hour	28,800			
Loss/Gain	Daily rate +15 sec. to -10 sec.			
Driving system	Automatic winding type (with manual winding function)			Manual winding type
Duration	Approx. 40 hours	Approx. 50 hours		Approx. 40 hours
Jewels	25 jewels	31 jewels	28 jewels	31 jewels

Cal. NO	6S37	6S77	6S78
Features	Hour, minute, small seconds, center chronograph, chronograph 30-minute, and date, and power reserve indicator		Hour, minute, small seconds, center chronograph, chronograph 30-minute, and chronograph 12-hour hands, and date
Vibrations/hour	28,800		
Loss/Gain	Daily rate +15 sec. to -10 sec.		
Driving system	Automatic winding type (with manual winding function)		
Duration	Approx. 50 hours		
Jewels	40 jewels		34 jewels

Cal. NO	6S96	6S74	6S99
Features	Hour, minute, small seconds, center chronograph, chronograph 30-minute, and chronograph 12-hour hands, and power reserve indicator		
Vibrations/hour	28,800		
Loss/Gain	Daily rate +15 sec. to -10 sec.		
Driving system	Automatic winding type (with manual winding function)	Manual winding type	
Duration	Approx. 60 hours		
Jewels	38 jewels	35 jewels	

* The loss/gain specified above is factory-adjusted.

* Due to the mechanical watch mechanism, actual loss/gain may not fall within the range of the loss/gain specified above, depending on various environment or conditions (including temperatures, arm movement, the amount the mainspring is wound up, and other conditions in which the watch is worn).